

FOURSTEEL®

[heating products factory]

HEATING PRODUCTS DESIGNED
AND DEVELOPED BY FOURSTEEL®

24

VERSÃO PORTUGUESA

FOURSTEEL®

CORPORATE

A Foursteel é uma empresa portuguesa fabricante de radiadores de design de conceitos contemporâneos e minimalistas.

A aposta em I&D e em especial o foco nas necessidades do mercado em colaboração com arquitetos e designers têm permitido à Foursteel desenvolver soluções de produtos de aquecimento eficientes com estética apurada, sustentando o seu desenvolvimento a nível nacional e internacional.

FOURSTEEL® ÍNDICE



10
MINIMAL



14
MINIMAL X



16
M TUBE



18
M TUBE SQUARE



20
M TUBE ROUND



22
M SLIM



24
M SLIM SQUARE



26
FOURSLIM BY ARCH.



30
FOURSLIM ON OFF



32
FOURSLIM SQUARE



36
FOURSLIM SQUARE
ON OFF



38
FOURSLIM SQUARE
LED



40
SKINNY



44
STEEL GLAM



48
STEEL ELEGANCE



50
FOURFOZ



52
FOURFOZ ON OFF



54
STEEL WAVE



56
STEEL STONE



58
STEEL CLASSIC



60
STEEL GLAMOUR



62
STEEL STYLE



64
NEW SLIM



66
BASIC LINE



70
NEW BASIC



74
EMPRESS



76
OLD BEAUTY



78
REMIND



80
FLOOR REMIND



82
RETRO SPECIAL



84
DIAMOND



86
DIAMOND XS



87
ARENA TABLE



88
ARENA



90
CURVE



92
D LIGNE



94
DIVINE



96
LINEAR



98
PLANO MOVE

FOURSTEEL® ÍNDICE



100
PLANO PURE



102
PLANO PURE ON OFF



104
PLANO +



108
PLANO



110
DOMOTIC TOUCH



112
SWITCH ON OFF



114
MIMOO SWITCH



115
MIMOO SWITCH
ROUND



117
ELEMENTOS ELÉTRICOS



118
VÁLVULAS E RETENTORES



122
OUTROS ACESSÓRIOS

FOURSTEEL®

Foursteel, Lda
Centro Empresarial de Aveiro
Zona Industrial de Mamodeiro
3810-783 Aveiro
PORTUGAL

T +351 234 111 967

T +351 234 107 263

www.foursteel.eu

geral@foursteel.eu

+351 935 212 579

NOTAS IMPORTANTES:

1. Quando não identificado a posição do elemento elétrico será sempre colocado do lado inferior direito;
2. Todos os nossos radiadores elétricos são compostos por elemento elétrico e fluido térmico.
3. A Foursteel® reserva o direito de alteração, sem aviso prévio, de todos os produtos e desenhos que constem neste catálogo.
4. Todos os produtos Foursteel® são adaptáveis em termos de potências e dimensões.

CORES RAL: cores sujeitas a confirmação.

BRANCO: RAL 9016 satinado (RAL usado por definição)

Certificação dos produtos elétricos, segundo a norma:

IECEN 60335-2-43:

IEC 60335-1:2010 + COR1: 2010 + COR2:2011 + A1:2013 EN 60335-1:2012 + AC:2014 + A11:2014

IEC 60335-2-43:2002 + A1:2005 + A2:2008 EN 60335-2-43:2003 + A1:2006 + A2:2008

Certificação dos produtos de aquecimento central, segundo a norma UN:

EN442 - 2

Certificação UL:

UL 499 - Electric Heating Appliances

E506585



MINIMAL

SECA-TOALHAS

ARQUITETO: MANUEL AIRES MATEUS

Palácio Condes de Murça em Lisboa.





ACABAMENTOS

-  Polido
-  Escovado
-  Forja
-  Branco 9016 Satinado
-  Cor RAL

ACABAMENTOS PVD

-  Champagne
-  Ouro
-  Cobre
-  Gun Metal

ACESSÓRIOS

-  Domotic Touch
-  Mimoo Switch
-  Mimoo Switch Round

VERSÃO

-  Elétrico

MATERIAL

-  Aço Inoxidável

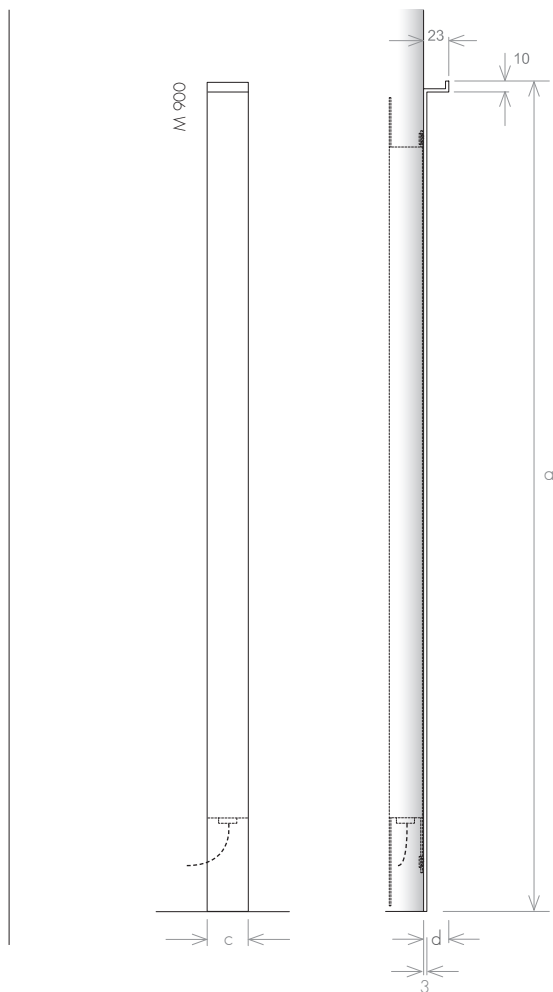

modelo		M 900	M 1200	M 1400	M 1800
altura (mm)	a	900	1200	1400	1800
largura total (mm)	c	35	35	35	35
profundidade (mm)	d	23	23	23	23
capacidade (l)		0,6	0,8	1,0	1,3
elétrico (W)		100	150	150	200

VISTA SUPERIOR

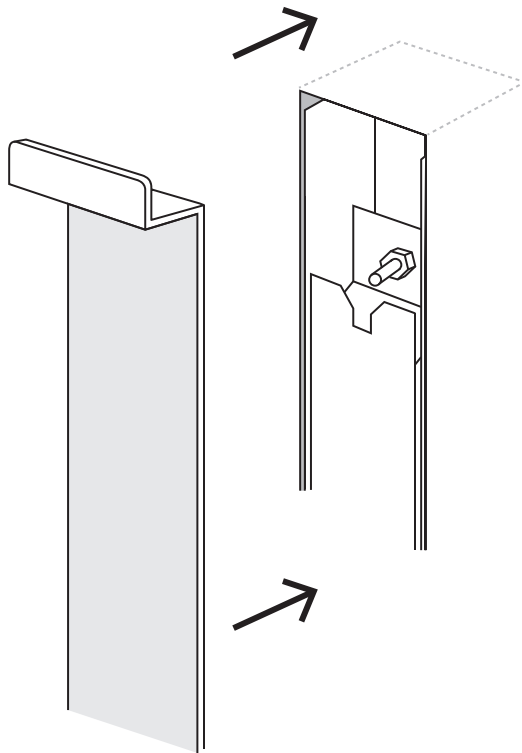
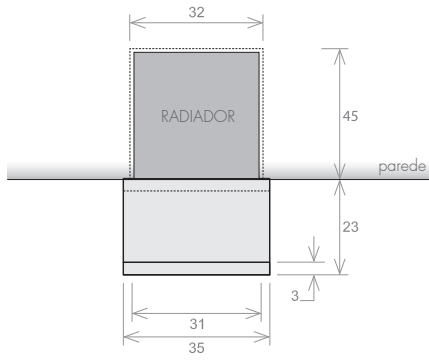



MINIMAL X

SECA-TOALHAS





VISTA LATERAL

VISTA FRONTAL

VISTA LATERAL

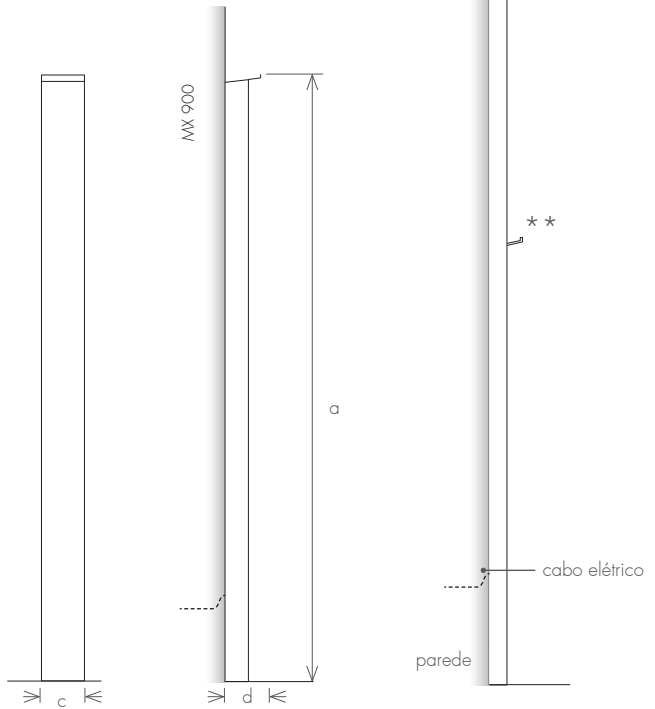

** o segundo suporte só é aplicado no modelo MX1800

modelo		MX 900	MX 1200	MX 1400	MX 1800
altura (mm)	a	900	1200	1400	1800
largura total (mm)	c	50	50	50	50
profundidade (mm)	d	50	50	50	50
capacidade (l)		0,6	0,8	1,0	1,3
elétrico (W)		100	150	150	200

M TUBE

SECA TOALHAS



ACABAMENTOS

-  Polido
-  Escovado
-  Forja
-  Branco 9016 Satinado
-  Cor RAL

ACABAMENTOS PVD

-  Champagne
-  Ouro
-  Cobre
-  Gun Metal

ACESSÓRIOS

-  Domotic Touch
-  Mimoo Switch
-  Mimoo Switch Round

VERSÃO



Elétrico

MATERIAL

/// Aço Inoxidável

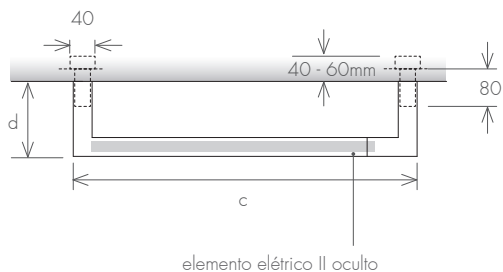
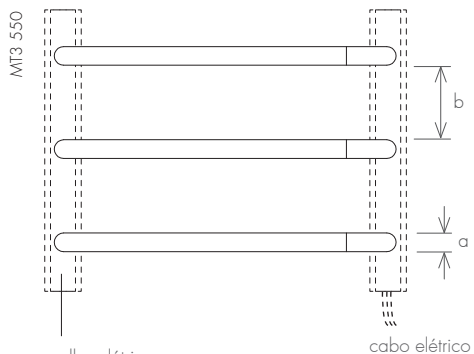

modelo	MT3 550	elem. adicional	MT3 800	elem. adicional
n° de elementos	3	1	3	1
altura dos elementos (mm) a	30	30	30	30
distância entre elementos (mm) b	120	-	120	-
largura total (mm) c	550	550	800	800
profundidade (mm) d	120	120	120	120
capacidade (l)	3x0,4	0,4	3x0,6	0,6
elétrico (W)	3x40	40	3x40	40

M TUBE SQUARE

SECA-TOALHAS





ACABAMENTOS

-  Polido
-  Escovado
-  Forja
-  Branco 9016 Satinado
-  Cor RAL

ACABAMENTOS PVD

-  Champagne
-  Ouro
-  Cobre
-  Gun Metal

ACESSÓRIOS

-  Domotic Touch
-  Mimoo Switch
-  Mimoo Switch Round

VERSÃO

-  Elétrico

MATERIAL

-  Aço Inoxidável

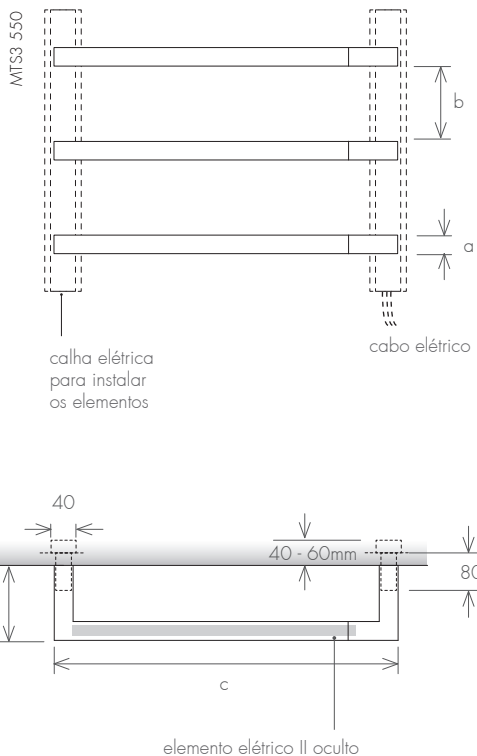

modelo	MTS3 550	elem. adicional	MTS3 800	elem. adicional
n° de elementos	3	1	3	1
altura dos elementos (mm)	a	30	30	30
distância entre elementos (mm)	b	120	-	120
largura total (mm)	c	550	550	800
profundidade (mm)	d	120	120	120
capacidade (l)		3x0,4	0,4	3x0,6
elétrico (W)		3x40	40	3x40

M TUBE ROUND

SECA-TOALHAS





ACABAMENTOS

-  Polido
-  Escovado
-  Forja
-  Branco 9016 Satinado
-  Cor RAL

ACABAMENTOS PVD

-  Champagne
-  Ouro
-  Cobre
-  Gun Metal

ACESSÓRIOS

-  Domotic Touch
-  Mimoo Switch
-  Mimoo Switch Round

VERSÃO



Elétrico

MATERIAL

/// Aço Inoxidável

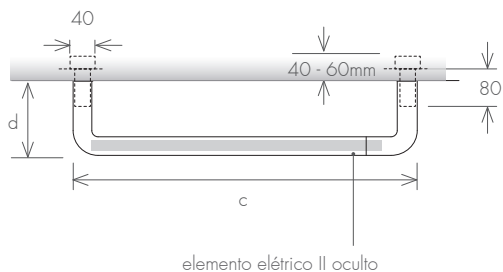
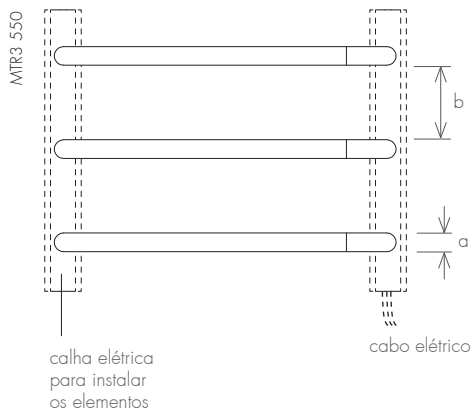

modelo		MTR3 550	elem. adicional	MTR3 800	elem. adicional
n° de elementos		3	1	3	1
altura dos elementos (mm)	a	30	30	30	30
distância entre elementos (mm)	b	120	-	120	-
largura total (mm)	c	550	550	800	800
profundidade (mm)	d	120	120	120	120
capacidade (l)		3x0,4	0,4	3x0,6	0,6
elétrico (W)		3x40	40	3x40	40



M SLIM

SECA-TOALHAS



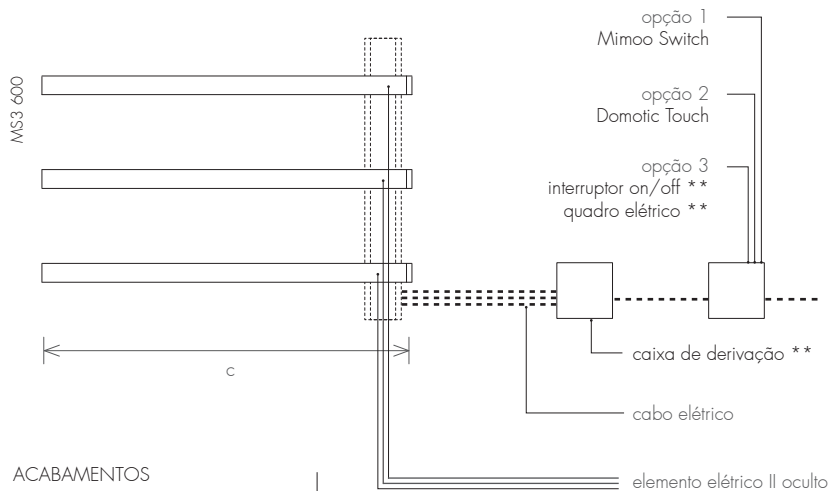

ACABAMENTOS

-  Polido
-  Escovado
-  Forja
-  Branco 9016 Satinado
-  Cor RAL

ACABAMENTOS PVD

-  Champagne
-  Ouro
-  Cobre
-  Gun Metal

ACESSÓRIOS

-  Domotic Touch
-  Mimoo Switch
-  Mimoo Switch Round

VERSÃO

-  Elétrico

MATERIAL

-  Aço Inoxidável

** Produtos não fornecidos pela Foursteel.

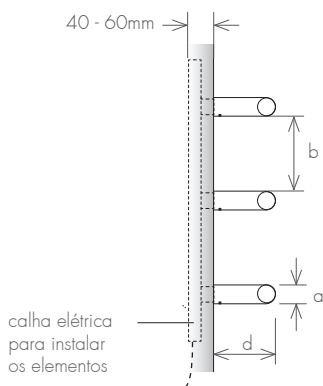

modelo	MS3 600	elem. adicional
n° de elementos	3	1
altura (mm) a	30	30
distância entre elementos (mm) b	120	-
largura total (mm) c	600	600
profundidade (mm) d	80	80
capacidade (l)	3x0,6	0,6
elétrico (W)	3x40	40



M SLIM SQUARE

SECA-TOALHAS

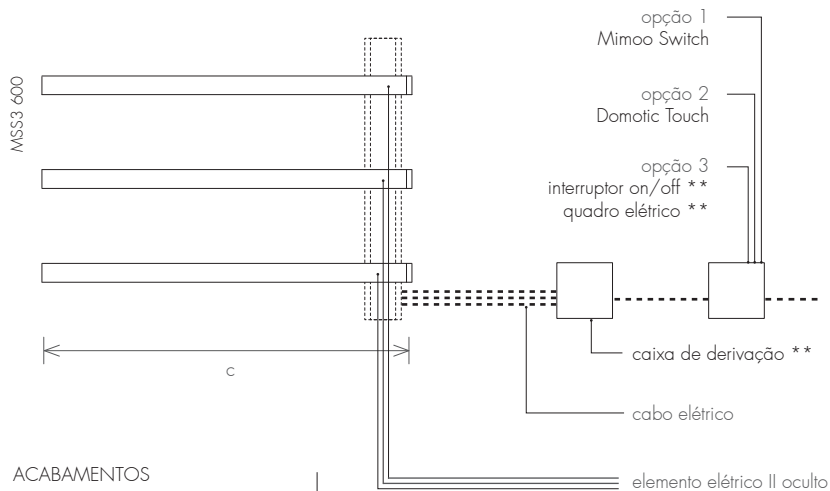



ACABAMENTOS

-  Polido
-  Escovado
-  Forja
-  Branco 9016 Satinado
-  Cor RAL

ACABAMENTOS PVD

-  Champagne
-  Ouro
-  Cobre
-  Gun Metal

ACESSÓRIOS

-  Domotic Touch
-  Mimoo Switch
-  Mimoo Switch Round

VERSÃO

-  Elétrico

MATERIAL

-  Aço Inoxidável

** Produtos não fornecidos pela Foursteel.

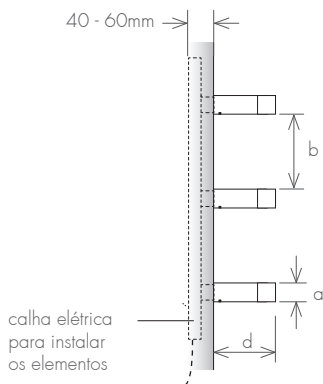

modelo	MSS3 600	elem. adicional
n° de elementos	3	1
altura (mm) a	30	30
distância entre elementos (mm) b	120	-
largura total (mm) c	600	600
profundidade (mm) d	80	80
capacidade (l)	3x0,6	0,6
elétrico (W)	3x40	40







ACABAMENTOS

-  Polido
-  Escovado
-  Forja
-  Branco 9016 Satinado
-  Cor RAL



ACABAMENTOS PVD

-  Champagne
-  Ouro
-  Cobre
-  Gun Metal

ACESSÓRIOS

-  Domotic Touch
-  Mimoo Switch
-  Mimoo Switch Round
-  Kit Mural

VERSÃO

-  Aquecimento Central
-  Elétrico
-  Misto

MATERIAL

-  Aço Inoxidável

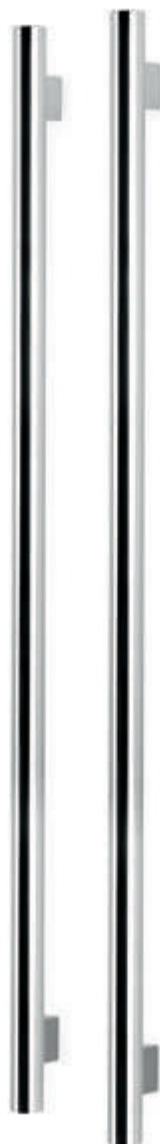

vendido separadamente

FOURSLIM BY ARCH.

SECA-TOALHAS

AQUECIMENTO CENTRAL - solução 1

A ligação da entrada de águas é feita por um sistema de torneiras no exterior do produto.

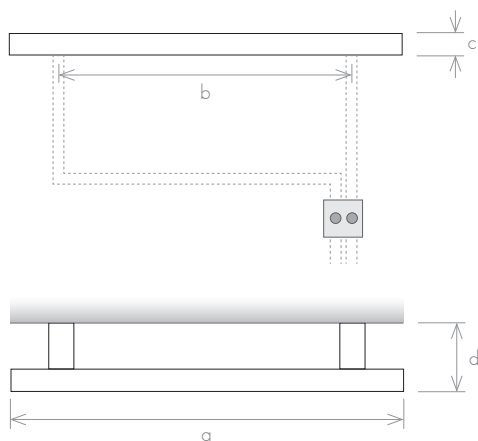

AQUECIMENTO CENTRAL - solução 2

Torneiras ocultas

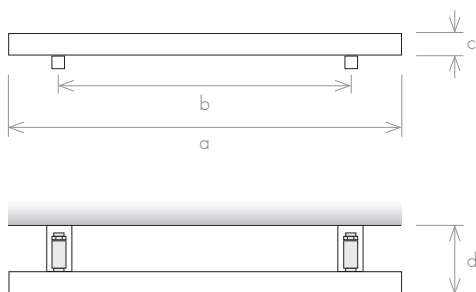

aquec. central - sistema mural			aquec. central - torneiras			
FSA 800	FSA 1200	FSA 1400	FSA 800	FSA 1200	FSA 1400	modelo
800	1200	1400	800	1200	1400	a (mm) altura
620	1020	1220	620	1020	1220	b (mm) distância entre eixos
42	42	42	42	42	42	c (mm) largura total
100	100	100	130	130	130	d (mm) profundidade
0,7	0,9	1,2	0,7	0,9	1,2	(l) capacidade
63	97	124	63	97	124	(W) aquecimento central

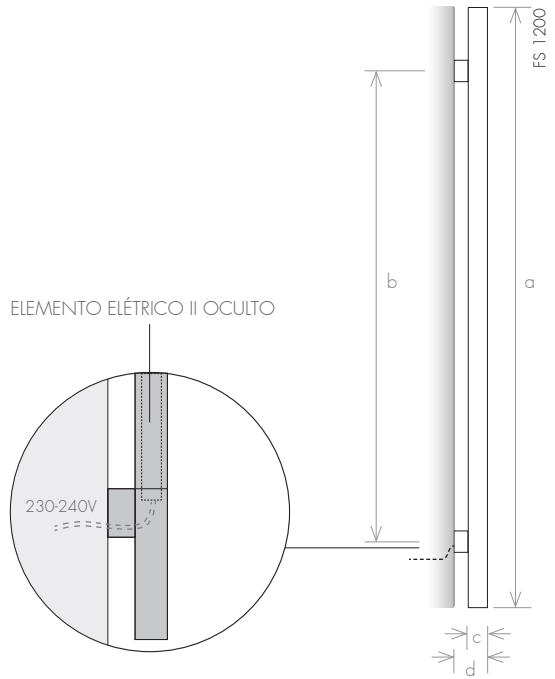

versão elétrica: na posição horizontal a profundidade é de 75mm

		elemento elétrico II oculto			versão misto - mural + elétrico II		
modelo		FS 800	FS 1200	FS 1400	FSM 800	FSM 1200	FSM 1400
altura (mm)	a	800	1200	1400	880	1280	1480
distância entre eixos (mm)	b	-	-	-	620	1020	1220
largura total (mm)	c	35	35	35	42	42	42
profundidade (mm)	d	65	65	65	100	100	100
capacidade (l)		0,6	0,8	1,0	0,7	0,9	1,2
aquecimento central (VV)		-	-	-	63	97	124
elétrico (VV)		40	100	100	40	100	100



FOURSLIM ON/OFF

SECA-TOALHAS





ACABAMENTOS

-  Polido
-  Escovado
-  Forja
-  Branco 9016 Satinado
-  Cor RAL



ACABAMENTOS PVD

-  Champagne
-  Ouro
-  Cobre
-  Gun Metal

ACESSÓRIOS

-  Domotic Touch
-  Mimoo Switch
-  Mimoo Switch Round
-  Kit Mural

VERSÃO

-  Aquecimento Central
-  Elétrico
-  Misto

MATERIAL

- /// Aço Inoxidável

VISTA INFERIOR



ELEMENTO ELÉTRICO II OCULTO

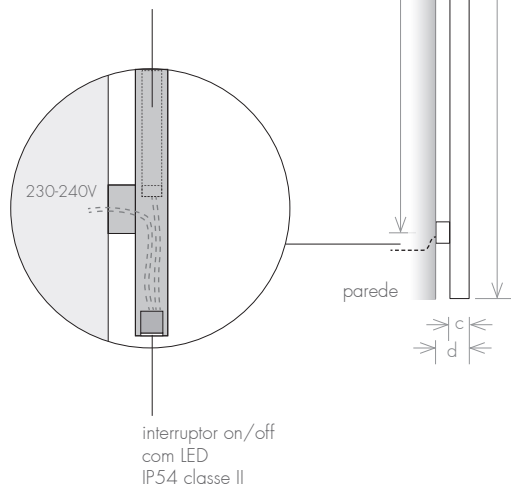

versão elétrica: na posição horizontal a profundidade é de 82mm

modelo	elem. elétrico II oculto - on/off			misto - sistema mural + on/off		
	FSO 800	FSO 1200	FSO 1400	FSOM 800	FSOM 1200	FSOM 1400
altura (mm)	a 800	1200	1400	800	1200	1400
distância entre eixos (mm)	b -	-	-	520	920	1120
largura total (mm)	c 42	42	42	42	42	42
profundidade (mm)	d 72	72	72	100	100	100
capacidade (l)	0,6	0,8	1,0	0,7	0,9	1,2
aquecimento central (W)	-	-	-	63	97	124
elétrico (W)	100	100	150	40	100	100



FOURSLIM SQUARE

SECA-TOALHAS





ACABAMENTOS

-  Polido
-  Escovado
-  Forja
-  Branco 9016 Satinado
-  Cor RAL



ACABAMENTOS PVD

-  Champagne
-  Ouro
-  Cobre
-  Gun Metal

ACESSÓRIOS

-  Domotic Touch
-  Mimoo Switch
-  Mimoo Switch Round
-  Kit Mural

VERSÃO

-  Aquecimento Central
-  Elétrico
-  Misto

MATERIAL

-  Aço Inoxidável



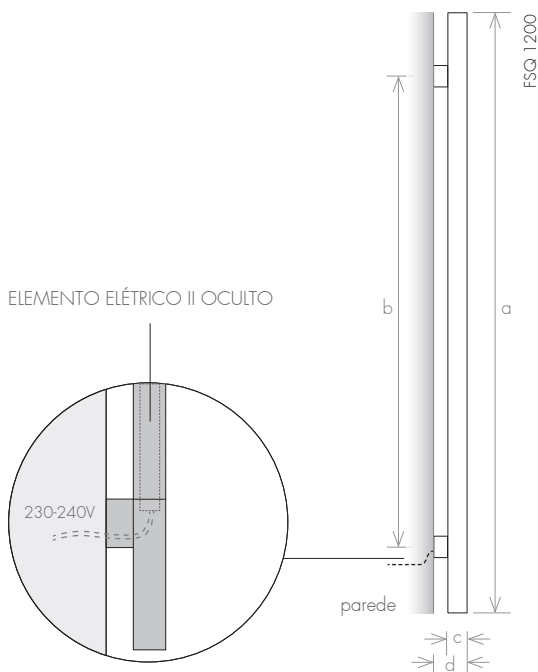

versão elétrica: na posição horizontal a profundidade é de 80mm

elemento elétrico II oculto			versão misto - mural + elétrico II			
FSQ 800	FSQ 1200	FSQ 1400	FSQM 800	FSQM 1200	FSQM 1400	modelo
800	1200	1400	880	1280	1480	a (mm) altura
-	-	-	620	1020	1220	b (mm) distância entre eixos
40	40	40	40	40	40	c (mm) largura total
70	70	70	98	98	98	d (mm) profundidade
0,6	0,8	1,0	0,7	0,9	1,2	(l) capacidade
-	-	-	63	97	124	(W) aquecimento central
100	100	150	40	100	100	(W) elétrico

AQUECIMENTO CENTRAL - solução 1

A ligação da entrada de águas é feita por um sistema de torneiras no exterior do produto.



AQUECIMENTO CENTRAL - solução 2

Torneiras ocultas

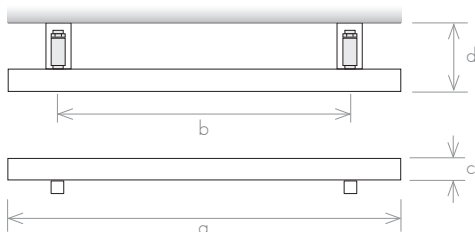

		aquec. central - sistema mural			aquec. central - torneiras		
modelo		FSQA 800	FSQA 1200	FSQA 1400	FSQA 800	FSQA 1200	FSQA 1400
altura	(mm) a	800	1200	1400	800	1200	1400
distância entre eixos	(mm) b	620	1020	1220	620	1020	1220
largura total	(mm) c	40	40	40	40	40	40
profundidade	(mm) d	98	98	98	128	128	128
capacidade	(l)	0,7	0,9	1,2	0,7	0,9	1,2
aquecimento central	(W)	63	97	124	63	97	124



FOURSLIM SQUARE ON/OFF

SECA-TOALHAS





ACABAMENTOS

-  Polido
-  Escovado
-  Forja
-  Branco 9016 Satinado
-  Cor RAL

ACABAMENTOS PVD

-  Champagne
-  Ouro
-  Cobre
-  Gun Metal

ACESSÓRIOS

-  Domotic Touch
-  Mimoo Switch
-  Mimoo Switch Round
-  Kit Mural

VERSÃO

-  Elétrico
-  Misto

MATERIAL

-  Aço Inoxidável

VERSÃO: ELÉTRICO II OCULTO

VISTA INFERIOR



ELEMENTO ELÉTRICO II OCULTO

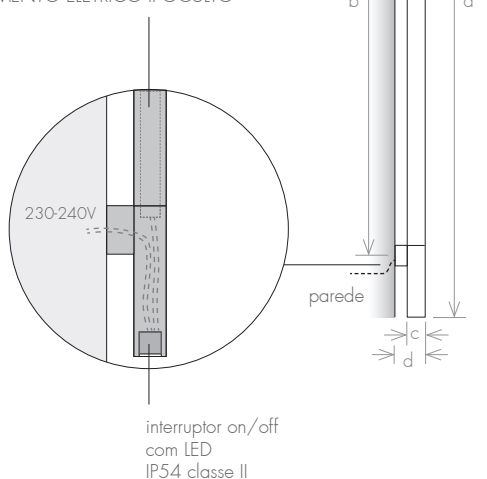

versão elétrica: na posição horizontal a profundidade é de 80mm

		elemento elétrico II oculto			versão misto - mural + elétrico II		
modelo		FSGO800	FSGO1200	FSGO1400	FSGQM800	FSGQM1200	FSGQM1400
altura (mm)	a	800	1200	1400	800	1200	1400
distância entre eixos (mm)	b	-	-	-	520	920	1120
largura total (mm)	c	40	40	40	40	40	40
profundidade (mm)	d	70	70	70	98	98	98
capacidade (l)		0,6	0,8	1,0	0,7	0,9	1,2
aquecimento central (W)		-	-	-	63	97	124
elétrico (W)		100	100	150	100	100	150

**FOURSLIM
SQUARE
LED**

SECA-TOALHAS





ACABAMENTOS

-  Polido
-  Escovado
-  Forja
-  Branco 9016 Satinado
-  Cor RAL

ACABAMENTOS PVD

-  Champagne
-  Ouro
-  Cobre
-  Gun Metal

ACESSÓRIOS

-  Domotic Touch
-  Mimoo Switch
-  Mimoo Switch Round

VERSÃO

-  Elétrico

MATERIAL

-  Aço Inoxidável

VERSÃO: ELÉTRICO II OCULTO

ELEMENTO ELÉTRICO II OCULTO

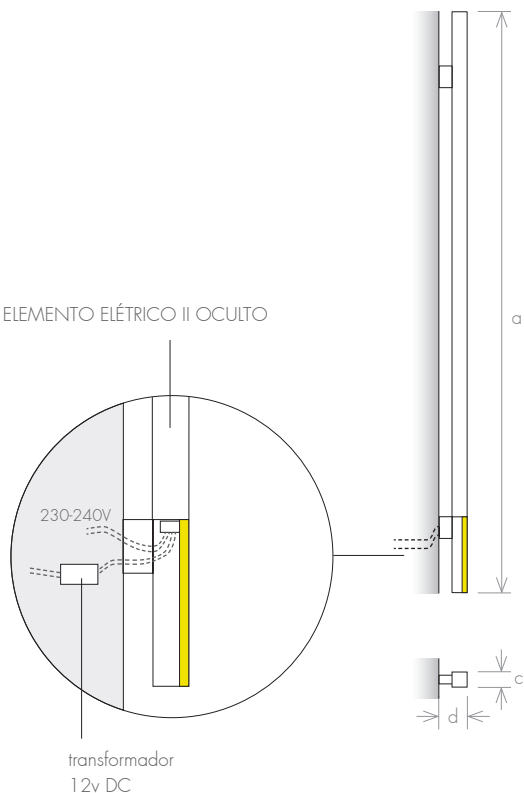

modelo		FSQL 800	FSQL 1200	FSQL 1400
altura (mm)	a	800	1200	1400
distância entre eixos (mm)	b	-	-	-
largura total (mm)	c	40	40	40
profundidade (mm)	d	70	70	70
capacidade (l)		0,6	0,8	1,0
elétrico (W)		100	100	150



SKINNY
SECA-TOALHAS



ACABAMENTOS

-  Polido
-  Escovado
-  Forja
-  Branco 9016 Satinado
-  Cor RAL

ACABAMENTOS PVD

-  Champagne
-  Ouro
-  Cobre
-  Gun Metal

ACESSÓRIOS

-  Domotic Touch
-  Mimoo Switch
-  Mimoo Switch Round

VERSÃO

-  Elétrico

MATERIAL

-  Aço Inoxidável

VERSÃO: FIXO AO CHÃO

ELEMENTO ELÉTRICO II OCULTO

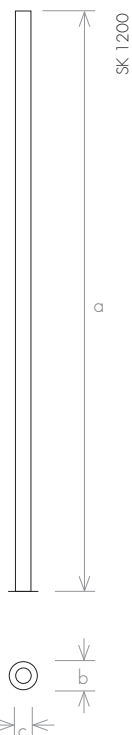
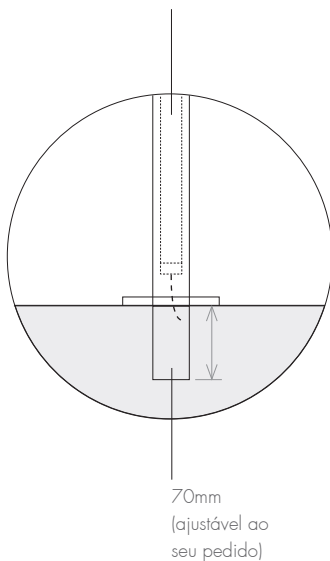

		fixo ao chão		
modelo		SK 900	SK 1200	SK 1400
altura (mm)	a	900	1200	1400
largura total (mm)	b	90	90	90
diâmetro do tubo (mm)	c	42	42	42
capacidade (l)		0,6	0,8	1,0
elétrico (W)		100	100	150



VERSÃO: MÓVEL

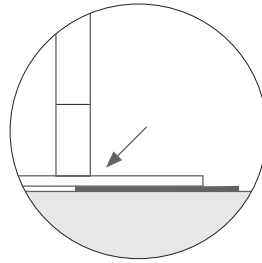
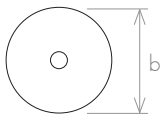
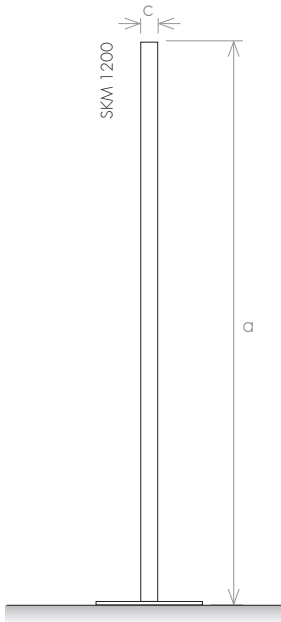

OPÇÃO A
saída do cabo elétrico
pela parte inferior

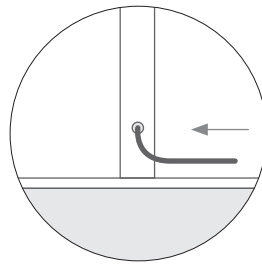

OPÇÃO B
saída lateral
do cabo elétrico

NOTA: Também disponível em versão "square".

		móvel		
modelo		SKM 900	SKM 1200	SKM 1400
altura (mm)	a	900	1200	1400
largura total (mm)	b	280	280	280
diâmetro do tubo (mm)	c	42	42	42
capacidade (l)		0,6	0,8	1,0
elétrico (W)		100	100	150



STEEL GLAM

RADIADOR TOALHEIRO

ACABAMENTOS





-  Polido
-  Escovado
-  Forja
-  Branco 9016 Satinado
-  Cor RAL

ACABAMENTOS PVD



dimensões máximas de 1000mm

-  Champagne
-  Ouro
-  Cobre
-  Gun Metal

ACESSÓRIOS

-  Domotic Touch
-  Mimoo Switch
-  Mimoo Switch Round
-  Kit Mural

VERSÃO

-  Aquecimento Central
-  Elétrico

MATERIAL

-  Aço Inoxidável



STEEL GLAM normal
(SG)



STEEL GLAM esquina viva
(SGS)

	modelo	SG 800E	SG 800L	SG 1200E	SG 1200L	SG 1800E	SG 1800L
altura (mm)	a	800	800	1200	1200	1800	1800
distância entre eixos (mm)	b	450	500	450	500	450	500
largura total (mm)	c	480	530	480	530	480	530
profundidade (mm)	d	90	90	90	90	90	90
capacidade (l)		2,8	3,1	4,0	4,6	6,6	7,1
aquecimento central (W)		250	296	360	438	613	657
elétrico (W)		300	300	600	600	1000	1000



VERSÃO: AQUECIMENTO CENTRAL

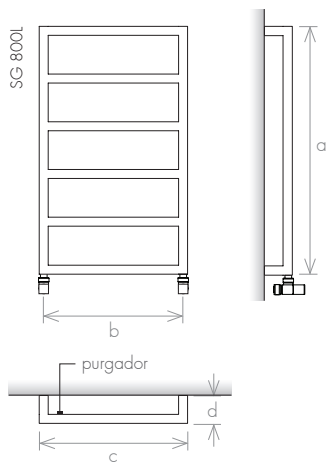

VERSÃO: ELÉTRICO IV

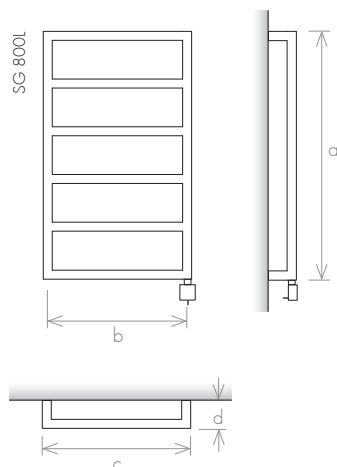

VERSÃO: ELÉTRICO II OCULTO

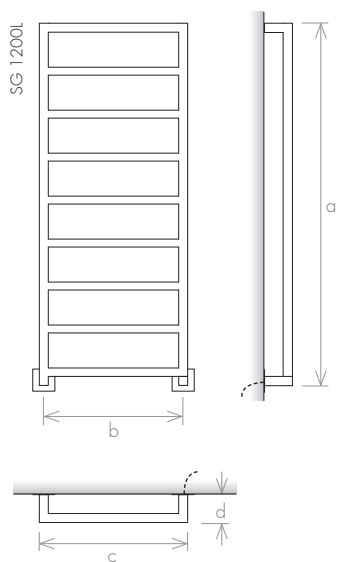

VERSÃO: MISTO COM ELEMENTO IV

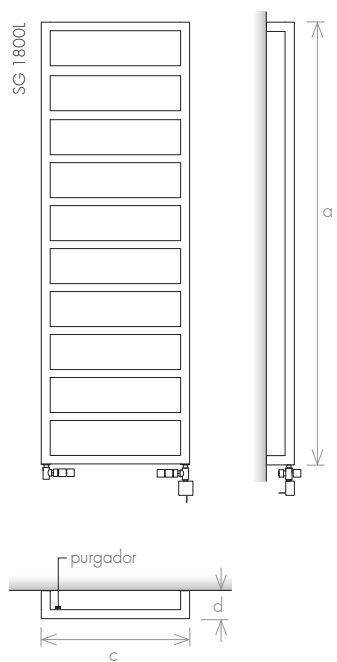



STEEL ELEGANCE

RADIADOR TOALHEIRO

ACABAMENTOS



ACESSÓRIOS

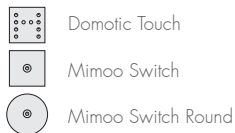

VERSÃO

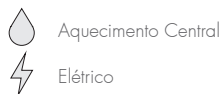

MATERIAL



VERSÃO: ELÉTRICO IV

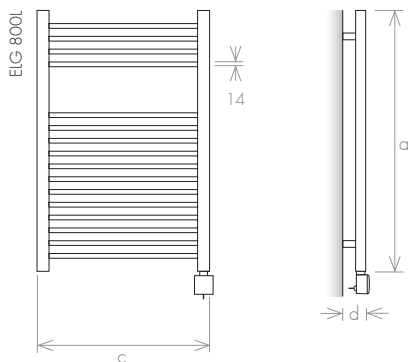

VERSÃO: AQUECIMENTO CENTRAL

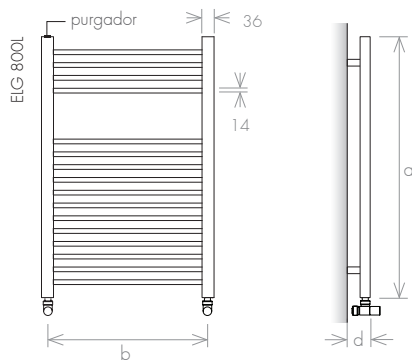

VERSÃO: ELÉTRICO V

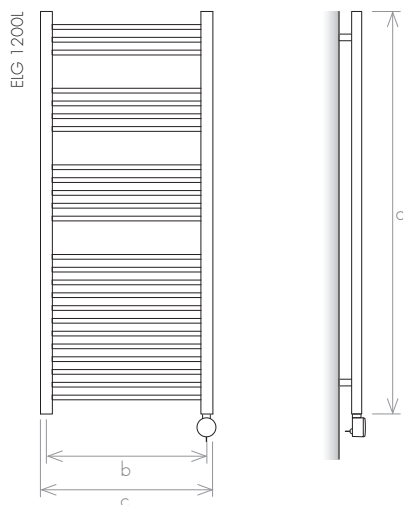

modelo		ELG 800E	ELG 800L	ELG 1200E	ELG 1200L	ELG 1800E	ELG 1800L
altura (mm)	a	800	800	1200	1200	1800	1800
distância entre eixos (mm)	b	450	500	450	500	450	500
largura total (mm)	c	480	530	480	530	480	530
profundidade (mm)	d	87	87	87	87	87	87
capacidade (l)		1,6	1,8	2,4	2,7	3,3	3,7
aquecimento central (W)		144	160	216	240	377	419
elétrico (W)		200	200	300	300	600	600

FOURFOZ

RADIADOR TOALHEIRO

ARQUITETO: EDUARDO SOUTO DE MOURA







ACABAMENTOS

-  Polido
-  Escovado
-  Forja
-  Branco 9016 Satinado
-  Cor RAL



ACABAMENTOS PVD

-  Champagne
-  Ouro
-  Cobre
-  Gun Metal

ACESSÓRIOS

-  Domotic Touch
-  Mimoo Switch
-  Mimoo Switch Round
-  Kit Mural

VERSÃO

-  Aquecimento Central
-  Elétrico
-  Misto

MATERIAL

-  Aço Inoxidável

VERSÃO: AQUECIMENTO CENTRAL

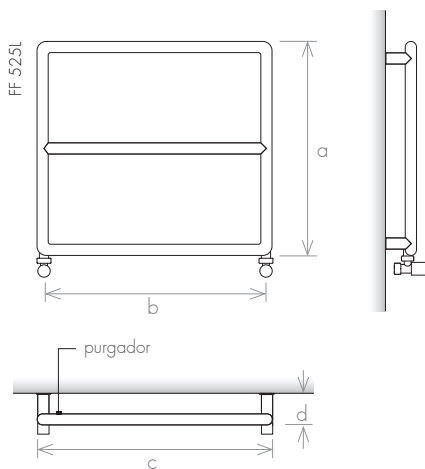

VERSÃO: ELÉTRICO II

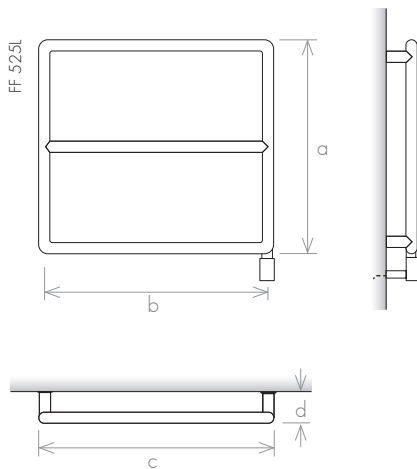

modelo		FF 525E	FF 525L	FF 800E	FF 800L
altura (mm)	a	525	525	800	800
distância entre eixos (mm)	b	450	500	450	500
largura total (mm)	c	475	525	475	525
profundidade (mm)	d	100	100	100	100
capacidade (l)		0,8	0,8	1,0	1,2
aquecimento central (W)		89	98	126	139
elétrico (W)		100	100	150	150



FOURFOZ ON OFF

RADIADOR TOALHEIRO

ARQUITETO: EDUARDO SOUTO DE MOURA



modelo		FFO 525E	FFO 525L	FFO 800E	FFO 800L
altura (mm)	a	525	525	800	800
distância entre eixos (mm)	b	450	500	450	500
largura total (mm)	c	475	525	475	525
profundidade (mm)	d	100	100	100	100
elétrico (W)		100	100	150	150



STEEL WAVE

RADIADOR TOALHEIRO

ACABAMENTOS



ACESSÓRIOS

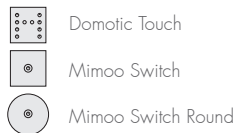

VERSÃO

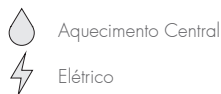

MATERIAL



VERSÃO: AQUECIMENTO CENTRAL

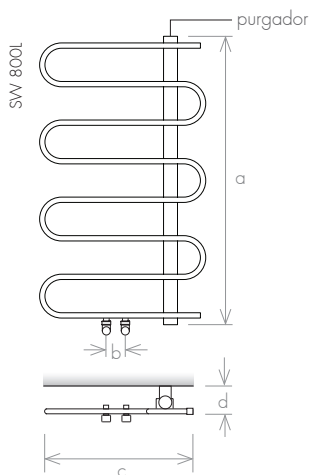

VERSÃO: ELÉTRICO V

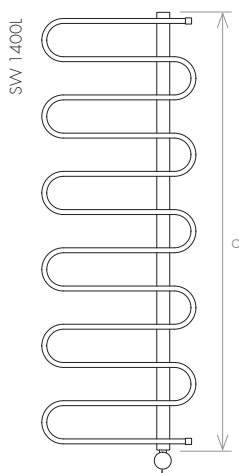

VERSÃO: ELÉTRICO II

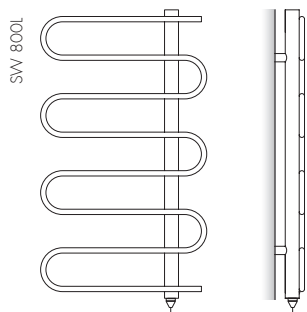

	modelo	SW800L	SW800XL	SW1200L	SW1200XL	SW1400L	SW1400XL
altura (mm)	a	868	868	1100	1100	1332	1332
distância entre eixos (mm)	b	50	50	50	50	50	50
largura total (mm)	c	500	600	500	600	500	600
profundidade (mm)	d	90	90	90	90	90	90
capacidade (l)		3,1	3,5	4,0	4,6	6,1	6,9
aquecimento central (W)		279	317	360	438	545	616
elétrico (W)		200	200	300	300	600	600

STEEL STONE



RADIADOR TOALHEIRO





ACABAMENTOS

-  Polido
-  Escovado

ACESSÓRIOS

-  Domotic Touch
-  Mimoo Switch
-  Mimoo Switch Round

VERSÃO

-  Aquecimento Central
-  Elétrico

MATERIAL

-  Aço Inoxidável

O material de revestimento deverá suportar temperaturas até 120° C.
Material aconselhado: pedras naturais, como mármore e granito.
Pedra não incluída.

VERSÃO: AQUECIMENTO CENTRAL

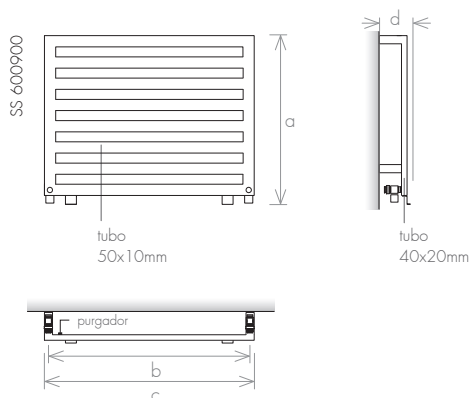

VERSÃO: ELÉTRICO II

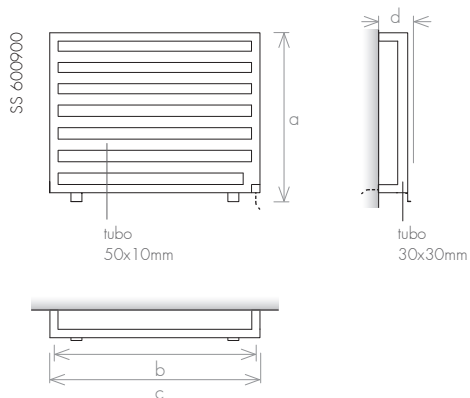

modelo		SS600600	SS400900	SS600900	SS4001200	SS6001200	SS8001200
altura (mm)	a	600	400	600	400	600	800
distância entre eixos (mm)	b	560	860	860	1160	1160	1160
largura total (mm)	c	600	900	900	1200	1200	1200
profundidade (mm)	d	110	110	110	110	110	110
capacidade (l)		3,6	4,2	4,7	5,6	5,8	7,2
aquecimento central (W)		322	379	419	500	524	647
elétrico (W)		300	300	600	600	600	1000



STEEL CLASSIC

RADIADOR TOALHEIRO

ACABAMENTOS



ACESSÓRIOS

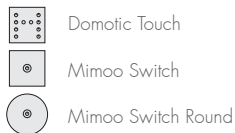

VERSÃO

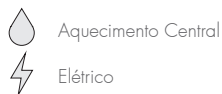

MATERIAL



VERSÃO: AQUECIMENTO CENTRAL

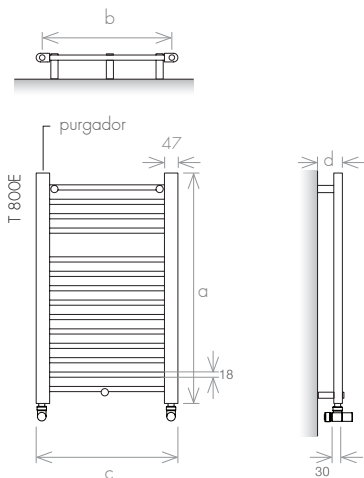

VERSÃO: ELÉTRICO V

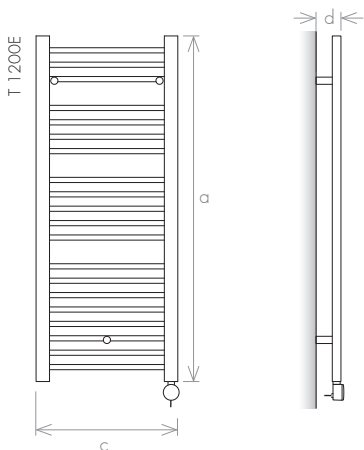

modelo		T 800E	T 800L	T 1200E	T 1200L	T 1800E	T 1800L
altura (mm)	a	800	800	1200	1200	1800	1800
distância entre eixos (mm)	b	450	500	450	500	450	500
largura total (mm)	c	492	542	492	542	492	542
profundidade (mm)	d	87	87	87	87	87	87
capacidade (l)		2,5	2,6	3,6	3,7	5,6	5,9
aquecimento central (W)		221	234	323	353	497	547
elétrico (W)		200	200	300	300	600	600



STEEL GLAMOUR

RADIADOR TOALHEIRO

ACABAMENTOS



ACESSÓRIOS

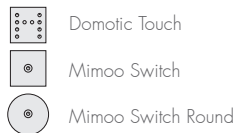

VERSÃO

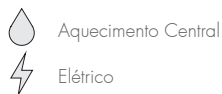

MATERIAL



VERSÃO: AQUECIMENTO CENTRAL

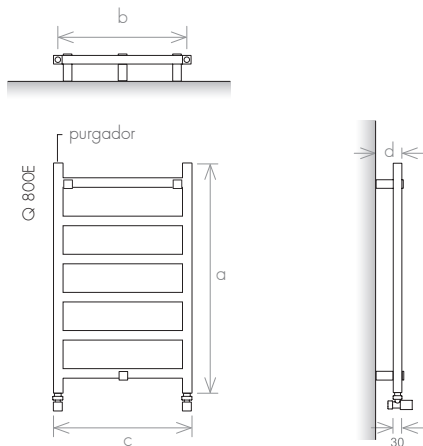

VERSÃO: ELÉTRICO II

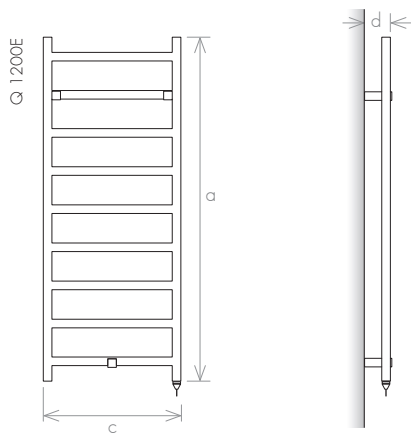



modelo		Q 800E	Q 800L	Q 1200E	Q 1200L	Q 1800E	Q 1800L
altura (mm)	a	800	800	1200	1200	1800	1800
distância entre eixos (mm)	b	450	500	450	500	450	500
largura total (mm)	c	480	530	480	530	480	530
profundidade (mm)	d	90	90	90	90	90	90
capacidade (l)		2,8	3,1	4,0	4,6	6,9	7,4
aquecimento central (W)		250	296	360	438	642	689
elétrico (W)		300	300	600	600	1000	1000



STEEL STYLE

RADIADOR TOALHEIRO



ACABAMENTOS

-  Forja
-  Branco 9016 Satinado

ACESSÓRIOS

-  Domotic Touch
-  Mimoo Switch
-  Mimoo Switch Round

VERSÃO

-  Aquecimento Central
-  Elétrico

MATERIAL

-  Aço Carbono

VERSÃO: AQUECIMENTO CENTRAL

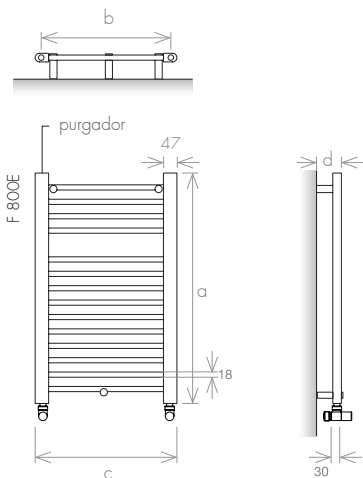

VERSÃO: ELÉTRICO V

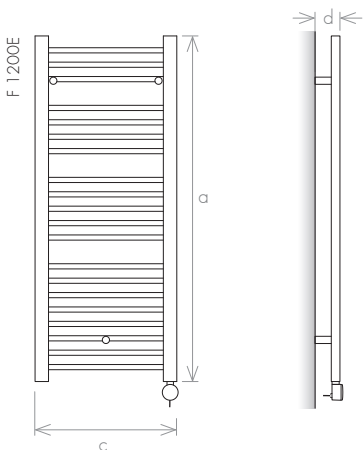

modelo		F 800E	F 800L	F 1200E	F 1200L	F 1800E	F 1800L
altura (mm)	a	800	800	1200	1200	1800	1800
distância entre eixos (mm)	b	450	500	450	500	450	500
largura total (mm)	c	492	542	492	542	492	542
profundidade (mm)	d	87	87	87	87	87	87
capacidade (l)		2,5	2,5	3,6	3,7	5,6	5,9
aquecimento central (W)		221	234	323	353	497	547
elétrico (W)		200	200	300	300	600	600



NEW SLIM

RADIADOR TOALHEIRO



ACABAMENTOS

-  Polido
-  Escovado
-  Forja
-  Branco 9016 Satinado
-  Cor RAL

ACESSÓRIOS

-  Domotic Touch
-  Mimoo Switch
-  Mimoo Switch Round

VERSÃO

-  Aquecimento Central
-  Elétrico
-  Misto

MATERIAL

-  Aço Inoxidável
-  Aço Carbono

VERSÃO: ELÉTRICO IV OU V

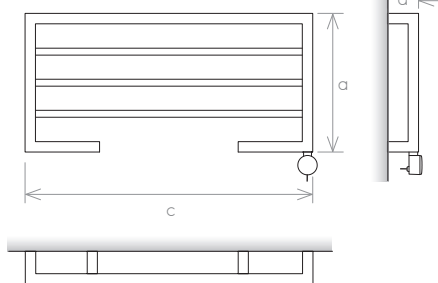

VERSÃO: AQUECIMENTO CENTRAL

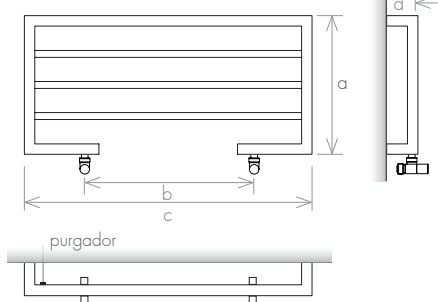

VERSÃO: MISTO

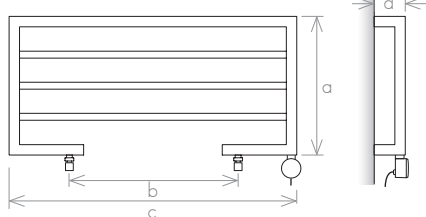

		aquecimento central		elétrico
modelo		NS 400 E	NS 400 L	NS 400
altura (mm)	a	400	400	400
distância entre eixos (mm)	b	450	500	-
largura total (mm)	c	830	830	830
profundidade (mm)	d	90	90	90
capacidade (l)		2,1	2,1	2,1
aquecimento central (W)		242	242	-
elétrico (W)		-	-	200

BASIC LINE

RADIADOR TOALHEIRO





ACABAMENTOS

-  Polido
-  Escovado
-  Forja
-  Branco 9016 Satinado
-  Cor RAL

ACESSÓRIOS

-  Domotic Touch
-  Mimoo Switch
-  Mimoo Switch Round

VERSÃO

-  Aquecimento Central
-  Elétrico
-  Misto

MATERIAL

-  Aço Inoxidável
-  Aço Carbono

VERSÃO: AQUECIMENTO CENTRAL

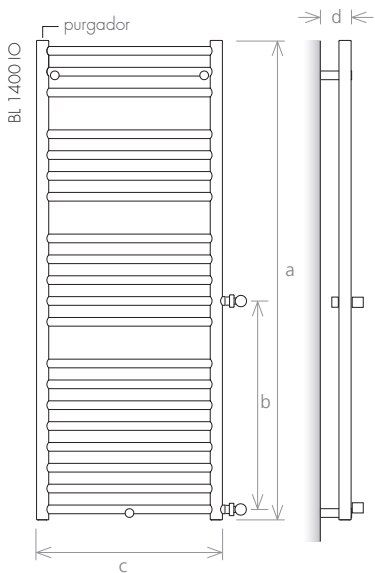
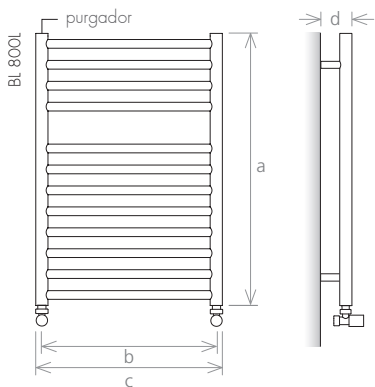

BL1400 IO (in&out) - Ligações laterais



BL800E	BL800L	BL800XL	BL1200E	BL1200L	BL1200XL	modelo
780	780	780	1200	1200	1200	a (mm) altura
450	500	600	450	500	600	b (mm) distância entre eixos
485	535	635	485	535	635	c (mm) largura total
90	90	90	90	90	90	d (mm) profundidade
2,90	3,16	3,68	4,19	4,56	5,29	(l) capacidade
259,1	282,2	328,5	374,4	407,1	472,7	(W) aquecimento central
300	300	300	600	600	600	(W) elétrico

VERSÃO: ELÉTRICO II - STANDARD

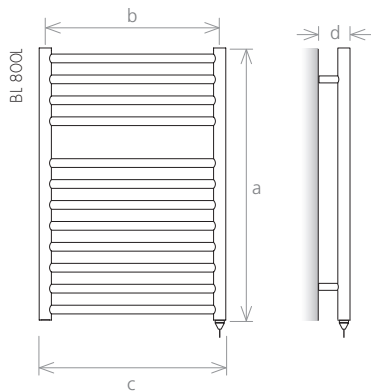

VERSÃO: MISTO

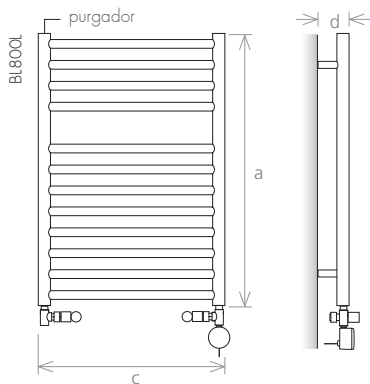

VERSÃO: ELÉTRICO III

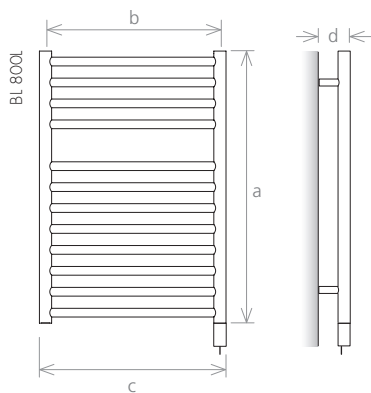

VERSÃO: ELÉTRICO II OCULTO

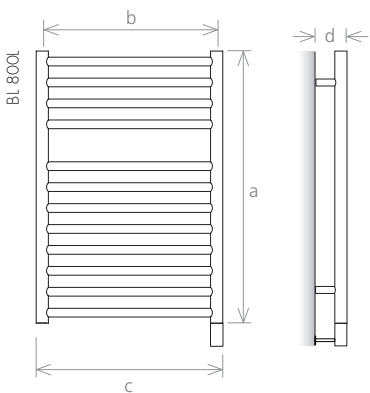

modelo		BL1400E	BL1400L	BL1400XL	BL1400 IO	BL1800E	BL1800L	BL1800XL
altura (mm)	a	1380	1380	1380	1380	1800	1800	1800
distância entre eixos (mm)	b	450	500	600	600	450	500	600
largura total (mm)	c	485	535	635	535	485	535	635
profundidade (mm)	d	90	90	90	90	90	90	90
capacidade (l)		4,90	5,33	6,19	5,33	6,55	7,14	8,30
aquecimento central (W)		437,8	476,2	553,0	476,2	585,5	637,5	741,7
elétrico (W)		600	600	600	-	1000	1000	1000
elétrico III (W)						900	900	900

NEW BASIC

RADIADOR TOALHEIRO

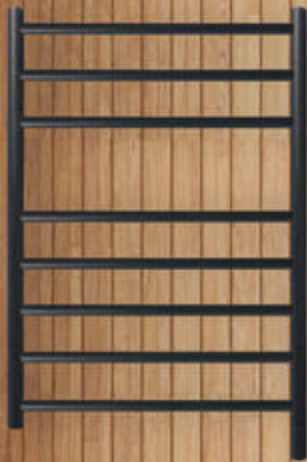



ACABAMENTOS

-  Polido
-  Escovado
-  Forja
-  Branco 9016 Satinado
-  Cor RAL

ACESSÓRIOS

-  Domotic Touch
-  Mimoo Switch
-  Mimoo Switch Round

VERSÃO

-  Aquecimento Central
-  Elétrico
-  Misto

MATERIAL

-  Aço Inoxidável
-  Aço Carbono

VERSÃO: MISTO

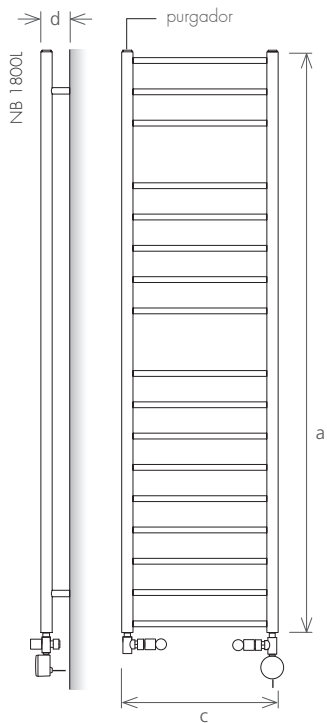

VERSÃO: AQUECIMENTO CENTRAL

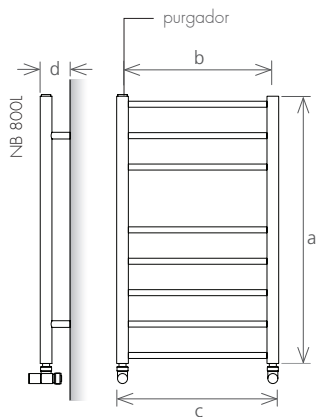

VERSÃO: ELÉTRICO II - STANDARD

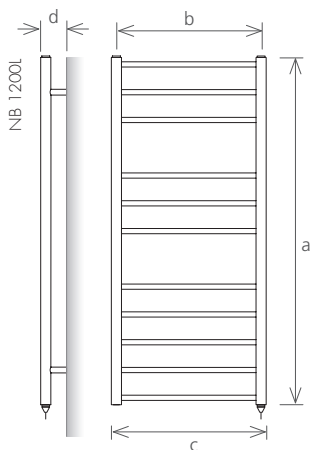

VERSÃO: ELÉTRICO II OCULTO

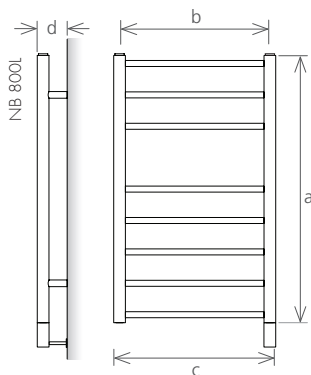

NB800E NB800L NB800XL NB1200E NB1200L NB1200XL

						modelo
800	800	800	1200	1200	1200	a (mm) altura
450	500	600	450	500	600	b (mm) distância entre eixos
485	535	635	485	535	635	c (mm) largura total
90	90	90	90	90	90	d (mm) profundidade
2,5	2,5	2,7	3,6	3,7	3,9	(l) capacidade
218	226	293	318	329	351	(W) aquecimento central
200	200	200	300	300	300	(W) elétrico
150	150	150				(W) elétrico III

VERSÃO: AQUECIMENTO CENTRAL

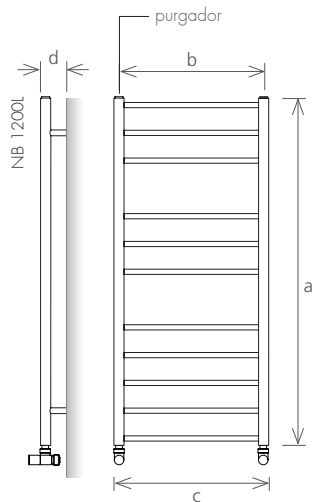

VERSÃO: ELÉTRICO III

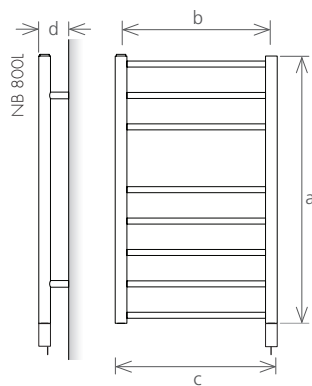

modelo		NB1400E	NB1400L	NB1400XL	NB1400IO	NB1800E	NB1800L	NB1800XL
altura (mm)	a	1448	1448	1448	1448	1800	1800	1800
distância entre eixos (mm)	b	450	500	600	500	450	500	600
largura total (mm)	c	485	535	635	535	485	535	635
profundidade (mm)	d	90	90	90	90	90	90	90
capacidade (l)		4,3	4,5	4,8	4,5	5,4	5,6	6,0
aquecimento central (W)		381	396	423	396	481	499	532
elétrico (W)		300	300	300	-	600	600	600



Empress
RADIADOR TOALHEIRO



ACABAMENTOS



ACABAMENTOS PVD

dimensões máximas de 1000mm



ACESSÓRIOS

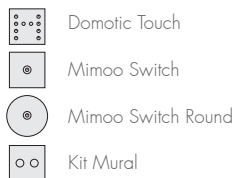

VERSÃO

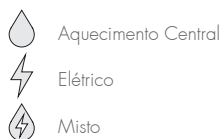

MATERIAL



VERSÃO: ELÉTRICO II OCULTO

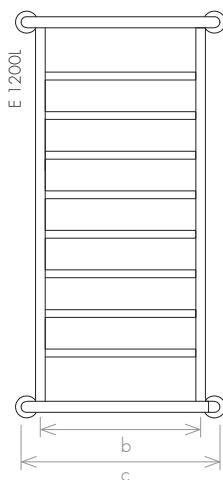

VERSÃO: MISTO

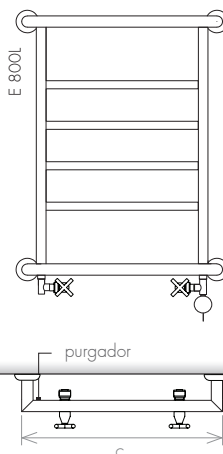

modelo	E 800E	E 800L	E 1200E	E 1200L	E 1800E	E 1800L
altura (mm) a	800	800	1200	1200	1800	1800
distância entre eixos (mm) b	450	500	450	500	450	500
largura total (mm) c	570	620	570	620	570	620
profundidade (mm) d	120	120	120	120	120	120
capacidade (l)	2,22	2,29	3,27	3,41	4,49	4,70
aquecimento central (W)	200	206	294	307	404	423
elétrico (W)	200	200	300	300	600	600



Old Beauty
RADIADOR TOALHEIRO





ACABAMENTOS

-  Polido
-  Escovado



ACABAMENTOS PVD
dimensões máximas de 1000mm

-  Champagne
-  Ouro
-  Cobre
-  Gun Metal

ACESSÓRIOS

-  Domotic Touch
-  Mimoo Switch
-  Mimoo Switch Round
-  Kit Mural

VERSÃO

-  Aquecimento Central
-  Elétrico
-  Misto

MATERIAL

-  Aço Inoxidável

VERSÃO: AQUECIMENTO CENTRAL

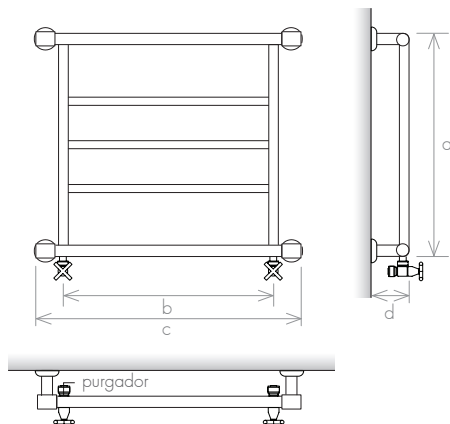

VERSÃO: ELÉTRICO II OCULTO

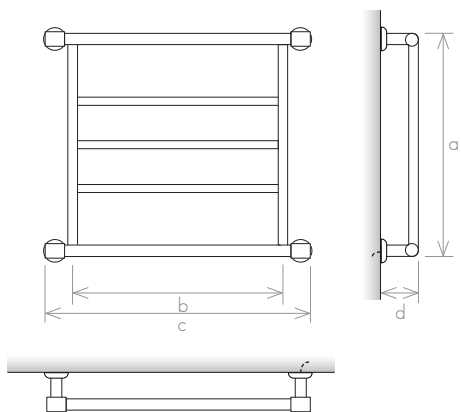

modelo		OB 800
altura (mm)	a	690
distância entre eixos (mm)	b	650
largura total (mm)	c	820
profundidade (mm)	d	120
capacidade (l)		2,61
aquecimento central (W)		235
elétrico (W)		600



Remind

RADIADOR TOALHEIRO

ACABAMENTOS



ACABAMENTOS PVD dimensões máximas de 1000mm



ACESSÓRIOS

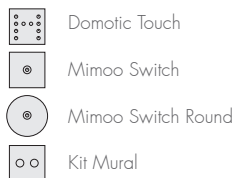

VERSÃO

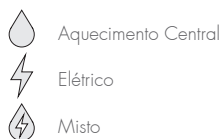

MATERIAL



VERSÃO: AQUECIMENTO CENTRAL

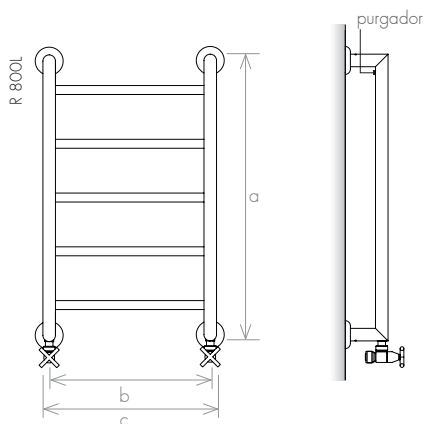

VERSÃO: ELÉTRICO II OCULTO

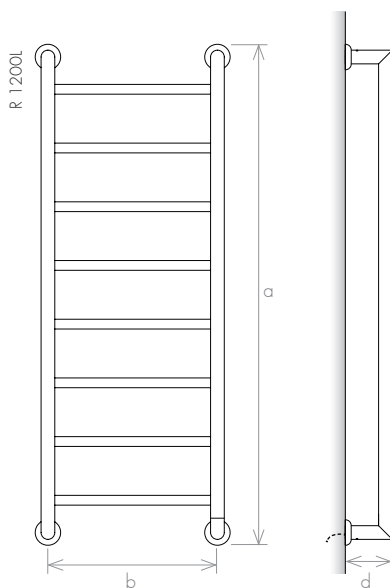

modelo	R 800E	R 800L	R 1200E	R 1200L	R 1800E	R 1800L
altura (mm)	a 800	800	1250	1250	1850	1850
distância entre eixos (mm)	b 450	500	450	500	450	500
largura total (mm)	c 485	535	485	535	485	535
profundidade (mm)	d 120	120	120	120	120	120
capacidade (l)	1,84	1,93	2,90	3,03	4,31	4,51
aquecimento central (W)	165	174	261	272	387	405
elétrico (W)	200	200	300	300	600	600



Floor Remind

RADIADOR TOALHEIRO

ACABAMENTOS



ACABAMENTOS PVD
dimensões máximas de 1000mm



ACESSÓRIOS



VERSÃO

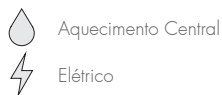

MATERIAL



VERSÃO: AQUECIMENTO CENTRAL

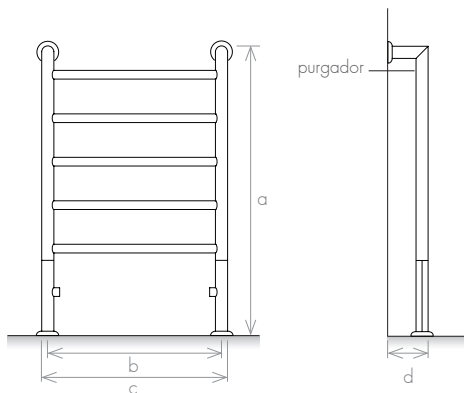

VERSÃO: ELÉTRICO II OCULTO

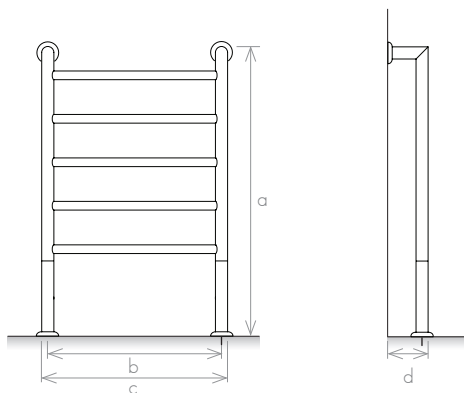

modelo		FR 1000	FR 1200	FR 1400
altura (mm)	a	1000	1200	1400
distância entre eixos (mm)	b	600	600	600
largura total (mm)	c	642	642	642
profundidade (mm)	d	140	140	140
capacidade (l)		3,69	4,26	5,17
aquecimento central (W)		332	398	465
elétrico (W)		300	300	600

Retro Special

RADIADOR TOALHEIRO



modelo		RE600400	RE600450	RE600500	RE600600	RE800400	RE800450
altura (mm)	a	600	600	600	600	800	800
distância entre eixos (mm)	b	400	450	500	600	400	450
largura total (mm)	c	435	485	535	635	435	485
profundidade (mm)	d	90	90	90	90	90	90
capacidade (l)		1,35	1,41	1,47	1,58	1,67	1,73
aquecimento central (W)		101	106	111	122	120	126
elétrico (W)		150	150	150	200	200	200



ACABAMENTOS

-  Polido
-  Escovado
-  Forja
-  Branco 9016 Satinado
-  Cor RAL



ACABAMENTOS PVD
dimensões máximas de 1000mm

-  Champagne
-  Ouro
-  Cobre
-  Gun Metal

ACESSÓRIOS

-  Domotic Touch
-  Mimoo Switch
-  Mimoo Switch Round

VERSÃO

-  Aquecimento Central
-  Elétrico
-  Misto

MATERIAL

-  Aço Inoxidável
-  Aço Carbono

VERSÃO: ELÉTRICO II

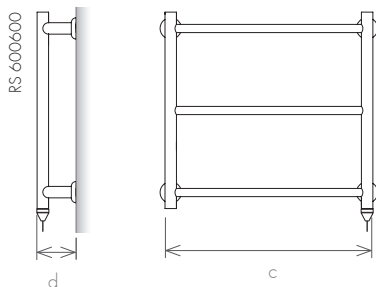

VERSÃO: ELÉTRICO IV OU V

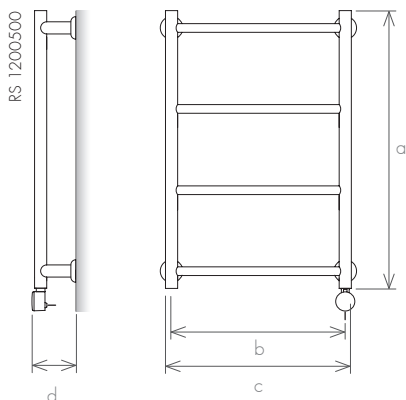

RE800500	RE800600	RE1000400RE	1000450	RE1000500	RE1000600	RE1200400	RE1200450	RE1200500	RE1200600
800	800	1000	1000	1000	1000	1200	1200	1200	1200
500	600	400	450	500	600	400	450	500	600
535	635	435	485	535	635	435	485	535	635
90	90	90	90	90	90	90	90	90	90
1,79	1,9	2,12	2,2	2,28	2,43	2,45	2,52	2,6	2,75
131	142	154	161	168	182	174	181	188	202
200	200	300	300	300	300	300	300	300	300

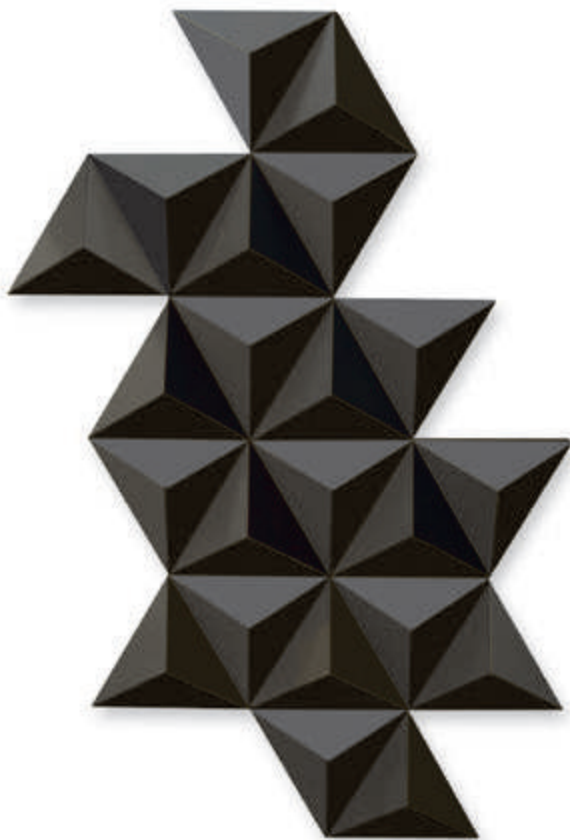

DIAMOND

DESIGN RADIATOR
DESIGNER: PATRICK PEDROSA





ACABAMENTOS

-  Polido
-  Escovado
-  Forja
-  Branco 9016 Satinado
-  Cor RAL



ACABAMENTOS PVD dimensões máximas de 1000mm

-  Champagne
-  Ouro
-  Cobre
-  Gun Metal

ACESSÓRIOS

-  Domotic Touch
-  Mimoo Switch
-  Mimoo Switch Round
-  Kit Mural

VERSÃO

-  Aquecimento Central
-  Elétrico

MATERIAL

-  Aço Inoxidável
-  Aço Carbono

VERSÃO: AQUECIMENTO CENTRAL

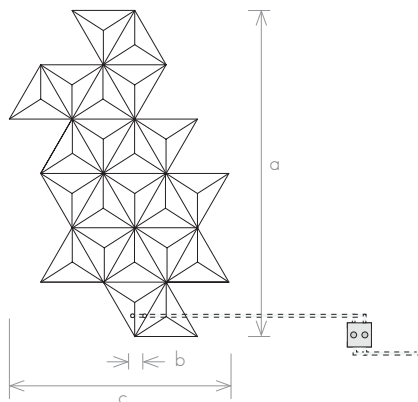

VERSÃO: ELÉTRICO II OCULTO

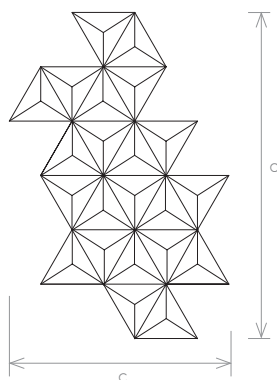

modelo		D 1500V	D 1200H
altura (mm)	a	1560	1050
distância entre eixos (mm)	b	50	50
largura total (mm)	c	1050	1560
profundidade (mm)		110	110
capacidade (l)		11,18	11,18
peso (kg)		≈ 75	≈ 75
aquecimento central (W)		1205	1205
elétrico (W)		1600-2000	1600-2000

DIAMOND XS



D XS	modelo
1040	a (mm) altura
50	b (mm) distância entre eixos
900	c (mm) largura total
110	d (mm) profundidade
4,75	(l) capacidade
≈ 35	(kg) peso
568	(W) aquecimento central
600-1000	(W) elétrico

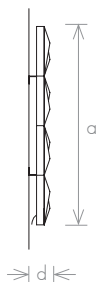
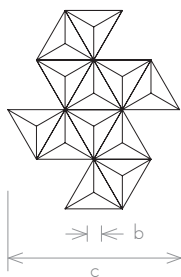

ARENA TABLE

DESIGN RADIATOR

DESIGNER: PATRICK PEDROSA

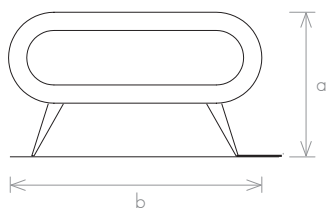
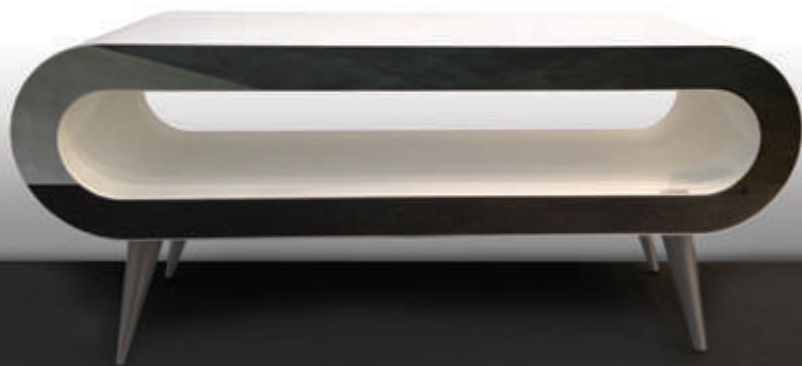

modelo		AT 1000	AT 1200	AT 1400
altura (mm)	a	535	535	535
largura total (mm)	b	1000	1200	1400
profundidade (mm)		450	450	450
capacidade (l)		7,45	10,89	12,66
peso (kg)		~50	~65	~75
elétrico (W)		1000	1500	1500

ARENA

DESIGN RADIATOR

DESIGNER: PATRICK PEDROSA







ACABAMENTOS

-  Polido
-  Escovado
-  Farja
-  Branco 9016 Satinado
-  Cor RAL



ACABAMENTOS PVD dimensões máximas de 1000mm

-  Champagne
-  Ouro
-  Cobre
-  Gun Metal

ACESSÓRIOS

-  Domotic Touch
-  Mimoo Switch
-  Mimoo Switch Round
-  Kit Mural

VERSÃO

-  Aquecimento Central
-  Elétrico

MATERIAL

-  Aço Inoxidável
-  Aço Carbono

VERSÃO: AQUECIMENTO CENTRAL

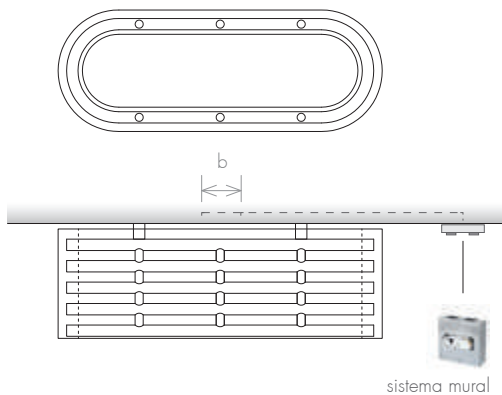

VERSÃO: ELÉTRICO II

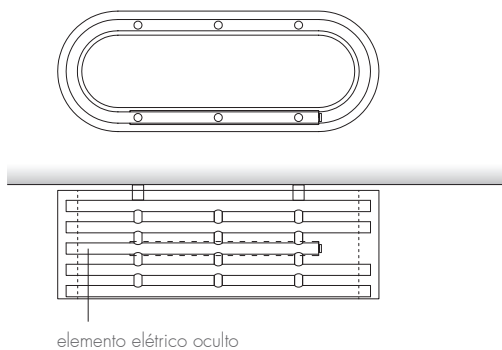

modelo		A 800	A 1200	A 1400
altura (mm)	a	300	300	300
distância entre eixos (mm)	b	50	50	50
largura total (mm)	c	800	1200	1400
profundidade (mm)	d	270	270	270
capacidade (l)		5,32	7,78	9,04
peso (kg)		~30	~45	~55
aquecimento central (W)		578	801	913
elétrico (W)		600	1000	1500

CURVE

ROOM RADIATOR



elétrico

C2301000 C2301500 C2302000 C3001000 C3001500 C3002000



modelo

230	230	230	300	300	300	a (mm)	altura
1000	1500	2000	1000	1500	2000	b (mm)	comprimento total
160	160	160	160	160	160	c (mm)	profundidade
1,3	2,1	2,9	1,3	2,1	2,9	d (mm)	capacidade
1600	1800	2000	1600	1800	2000	(W)	elétrico



ACABAMENTOS

-  Polido
-  Escovado
-  Forja
-  Branco 9016 Satinado
-  Cor RAL

ACESSÓRIOS

-  Domotic Touch
-  Mimoo Switch
-  Mimoo Switch Round

VERSÃO

-  Aquecimento Central
-  Elétrico

MATERIAL

-  Aço Inoxidável
-  Aço Carbono

VERSÃO ELÉTRICA COM ELEMENTO II OCULTO

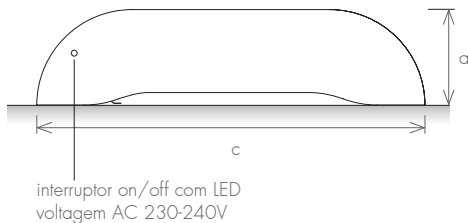

VERSÃO: AQUECIMENTO CENTRAL

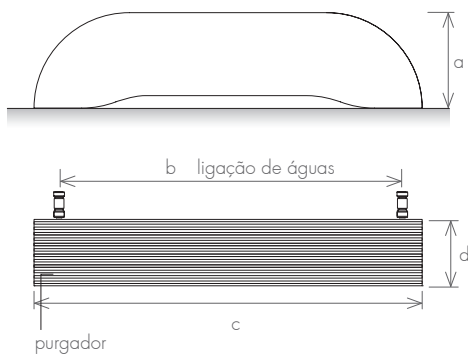

solução 1

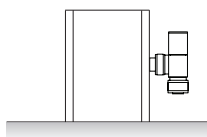

solução 2

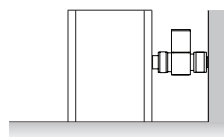

aquecimento central

modelo	C2301000	C2301500	C2302000	C3001000	C3001500	C3002000
altura (mm) a	230	230	230	300	300	300
comprimento total (mm) b	1000	1500	2000	1000	1500	2000
profundidade (mm) c	160	160	160	160	160	160
distância entre eixos (mm) d	800	1300	1800	800	1300	1800
aquecimento central (W)	872	1343	1787	1308	2015	2480

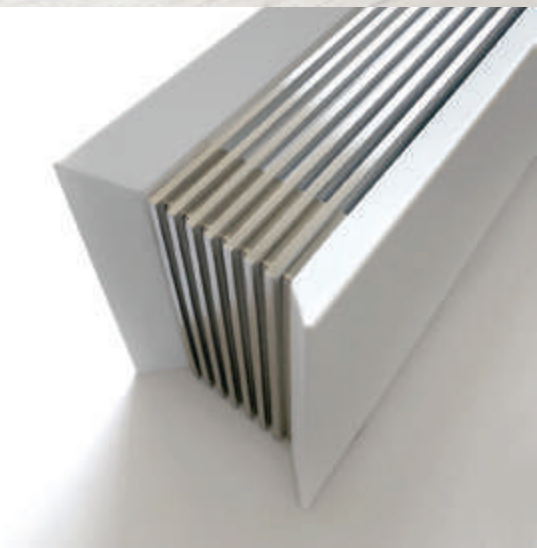

D LIGNE



ROOM RADIATOR

elétrico						
DL2301000	DL2301500	DL2302000	DL3001000	DL3001500	DL3002000	modelo
230	230	230	300	300	300	a (mm) altura
1000	1500	2000	1000	1500	2000	b (mm) comprimento total
160	160	160	160	160	160	c (mm) profundidade
1,4	2,2	3,0	1,4	2,2	3,0	d (mm) capacidade
1600	1800	2000	1600	1800	2000	(W) elétrico



ACABAMENTOS

-  Polido
-  Escovado
-  Forja
-  Branco 9016 Satinado
-  Cor RAL

ACESSÓRIOS

-  Domotic Touch
-  Mimoo Switch
-  Mimoo Switch Round

VERSÃO

-  Aquecimento Central
-  Elétrico

MATERIAL

-  Aço Inoxidável
-  Aço Carbono

VERSÃO ELÉTRICA COM ELEMENTO II OCULTO

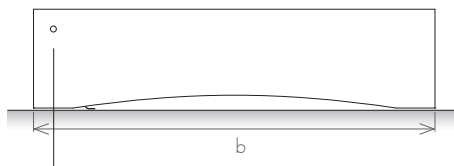

interruptor on/off com LED
voltagem AC 230-240V

VERSÃO: AQUECIMENTO CENTRAL

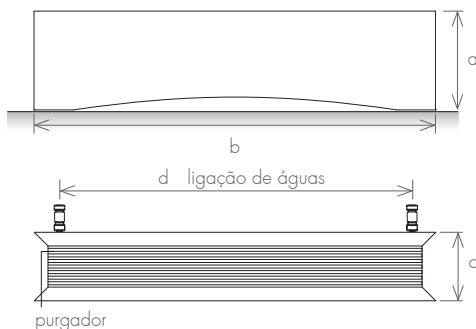

solução 1

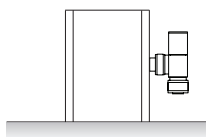

solução 2

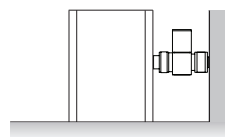

aquecimento central

modelo	DL2301000	DL2301500	DL2302000	DL3001000	DL3001500	DL3002000
altura (mm) a	230	230	230	300	300	300
comprimento total (mm) b	1000	1500	2000	1000	1500	2000
profundidade (mm) c	160	160	160	160	160	160
distância entre eixos (mm) d	860	1360	1860	860	1360	1860
aquecimento central (W)	948	1460	1942	1422	2190	2913

DIVINE

RADIATOR



elétrico

DI 1000 DI 1500 DI 2000 DI30 1000 DI30 1500 DI30 2000

modelo

230

230

230

300

300

300

a (mm) altura

1000

1500

2000

1000

1500

2000

b (mm) comprimento total

160

160

160

160

160

160

c (mm) profundidade

1,4

2,2

3,0

1,4

2,2

3,0

d (mm) capacidade

1600

1800

2000

1600

1800



2000

(W) elétrico



ACABAMENTOS

-  Polido
-  Escovado
-  Forja
-  Branco 9016 Satinado
-  Cor RAL

ACESSÓRIOS

-  Domotic Touch
-  Mimoo Switch
-  Mimoo Switch Round

VERSÃO

-  Aquecimento Central
-  Elétrico

MATERIAL

-  Aço Inoxidável
-  Aço Carbono

VERSÃO ELÉTRICA COM ELEMENTO II OCULTO

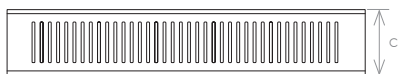
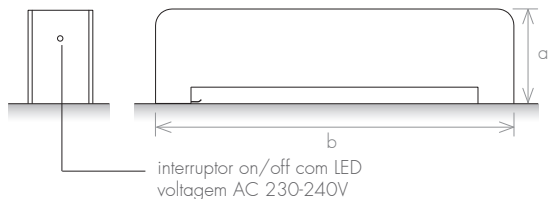

VERSÃO: AQUECIMENTO CENTRAL



solução 1

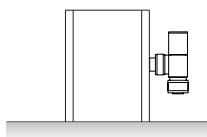

solução 2

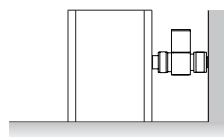

aquecimento central

modelo	DI 1000	DI 1500	DI 2000	DI30 1000	DI30 1500	DI30 2000
altura (mm) a	230	230	230	300	300	300
comprimento total (mm) b	1000	1500	2000	1000	1500	2000
profundidade (mm) c	160	160	160	160	160	160
distância entre eixos (mm) d	880	1380	1880	880	1380	1880
aquecimento central (W)	948	1460	1942	1422	2190	2913



LINEAR

RADIADOR

elétrico

LE 1000	LE 1500	LE 1000+	LE 1500+	LE 2000+	LE30 1000	LE30 1500	LE30 2000
240	240	240	240	240	310	310	310
1000	1500	1000	1500	2000	1000	1500	2000
100	100	160	160	160	160	160	160
1,4	2,2	1,4	2,2	3,0	1,4	2,2	3,0
1600	1800	1600	1800	2000	1600	1800	2000

modelo

- a (mm) altura
- b (mm) comprimento total
- c (mm) profundidade
- d (mm) capacidade
- (W) elétrico



ACABAMENTOS

-  Polido
-  Escovado
-  Forja
-  Branco 9016 Satinado
-  Cor RAL

ACESSÓRIOS

-  Domotic Touch
-  Mimoo Switch
-  Mimoo Switch Round

VERSÃO

-  Aquecimento Central
-  Elétrico

MATERIAL

-  Aço Inoxidável
-  Aço Carbono

VERSÃO: ELÉTRICA COM ELEMENTO II OCULTO

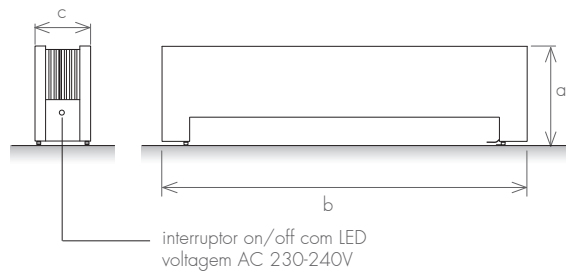

VERSÃO: AQUECIMENTO CENTRAL



solução 1

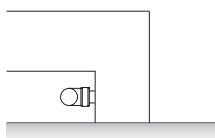

solução 2

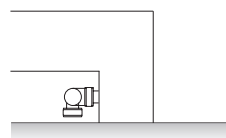

aquecimento central

modelo	LC 1000	LC 1500	LC 2000	LC30 1000	LC30 1500	LC30 2000
altura (mm) a	240	240	240	310	310	310
comprimento total (mm) b	1000	1500	2000	1000	1500	2000
profundidade (mm) c	160	160	160	160	160	160
distância entre eixos (mm) d	-	-	-	-	-	-
aquecimento central (W)	948	1460	1942	1422	2190	2913

PLANO MOVE

RADIADOR



modelo	PM400800	PM500800	PM600800	PM4001200	PM5001200	PM6001200	PM4001400
altura (mm) a	400	500	600	400	500	600	400
largura total (mm) c	800	800	800	1200	1200	1200	1400
profundidade (mm) d	40/60/90	40/60/90	40/60/90	40/60/90	40/60/90	40/60/90	40/60/90
elétrico (W)	300	300	600	600	600	600	600

modelo	PM800400	PM800500	PM800600	PM1200400	PM1200500	PM1200600	PM1400400
altura (mm) a	800	800	800	1200	1200	1200	1400
largura total (mm) c	400	500	600	400	500	600	400
profundidade (mm) d	40/60/90	40/60/90	40/60/90	40/60/90	40/60/90	40/60/90	40/60/90
elétrico (W)	300	300	600	600	600	600	600

ACABAMENTOS

-  Polido
-  Escovado
-  Forja
-  Branco 9016 Satinado
-  Cor RAL

ACESSÓRIOS

-  Domotic Touch
-  Mimoo Switch
-  Mimoo Switch Round

VERSÃO

-  Elétrico

MATERIAL

-  Aço Inoxidável
-  Aço Carbono

NOTA

Elemento elétrico com fluido térmico

VERSÃO: ELÉTRICA COM ELEMENTO II OCULTO

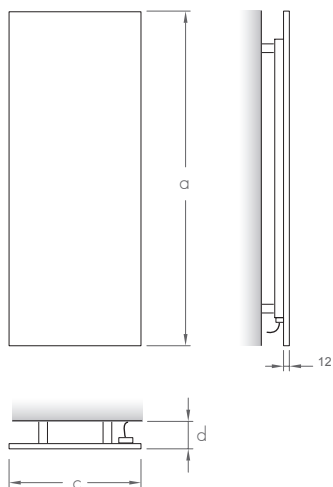
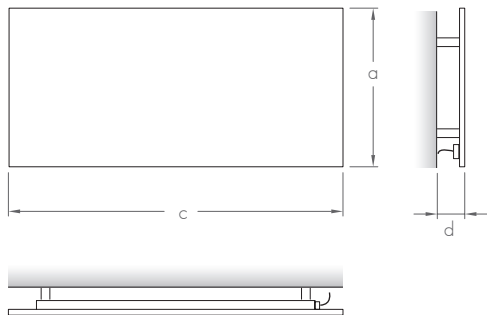

PM5001400	PM6001400	PM4001800	PM5001800	PM6001800	PM4002000	PM5002000	PM6002000
500	600	400	500	600	400	500	600
1400	1400	1800	1800	1800	2000	2000	2000
40/60/90	40/60/90	40/60/90	40/60/90	40/60/90	40/60/90	40/60/90	40/60/90
600	600	600	600	1000	1000	1000	1000
PM1400500	PM1400600	PM1800400	PM1800500	PM1800600	PM2000400	PM2000500	PM2000600
1400	1400	1800	1800	1800	2000	2000	2000
500	600	400	500	600	400	500	600
40/60/90	40/60/90	40/60/90	40/60/90	40/60/90	40/60/90	40/60/90	40/60/90
600	600	600	600	1000	1000	1000	1000

PLANO PURE

RADIADOR

* Diferentes posições entre eixos das torneiras à escolha do cliente.

** A profundidade pode ser inferior a 80mm.

PP6501200	PP6501800	PP6502000	PP10001000	PP1800550	PP2000550	PP1800650	PP2000650	modelo
650	650	650	1000	1800	2000	1800	2000	a (mm) altura
-	-	-	-	-	-	-	-	b (mm) * distância entre eixos
1200	1800	2000	1000	550	550	650	650	c (mm) largura total
80	80	80	80	80	80	80	80	d (mm) ** profundidade
26,03	33,31	36,99	28,96	27,88	28,96	33,31	36,99	(l) capacidade
47,4	69,8	77,1	64,6	59,1	75,2	69,8	77,1	(kg) peso
2512	3768	4187	3382	3267	3630	3768	4187	(W) aquecimento central
1200	1600	2000	1200	1600	2000	1600	2000	(W) elétrico II
-	-	-	-	1000	1000	1000	1000	(W) elétrico IV



ACABAMENTOS

-  Polido
-  Escovado
-  Forja
-  Branco 9016 Satinado
-  Cor RAL

ACESSÓRIOS

-  Domotic Touch
-  Mimoo Switch
-  Mimoo Switch Round

VERSÃO

-  Aquecimento Central
-  Elétrico

MATERIAL

-  Aço Inoxidável
-  Aço Carbono

VERSÃO: ELÉTRICA II

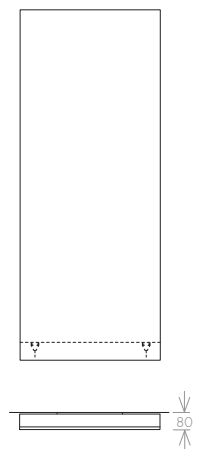

VERSÃO: ELÉTRICA IV

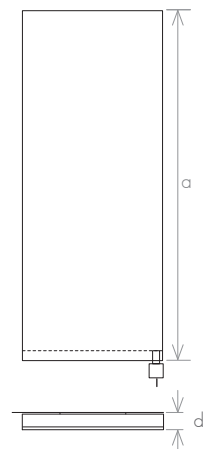

VERSÃO: ELÉTRICA II

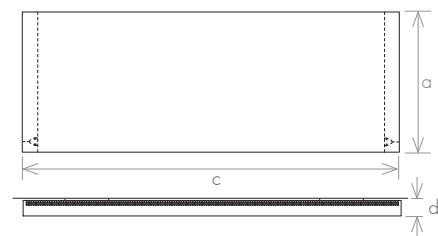

VERSÃO: AQUECIMENTO CENTRAL

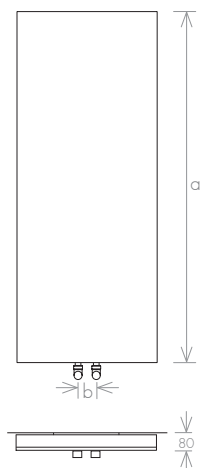

VERSÃO: AQUECIMENTO CENTRAL

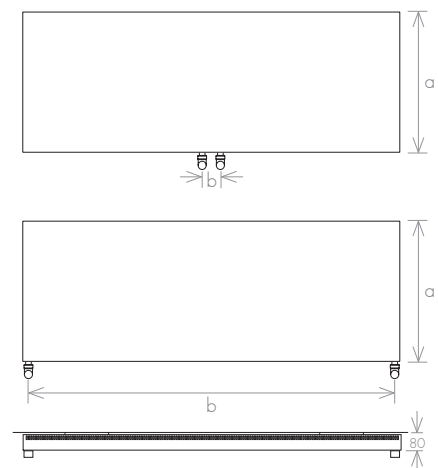



PLANO PURE ON/OFF

RADIADOR



ACABAMENTOS

-  Polido
-  Escovado
-  Forja
-  Branco 9016 Satinado
-  Cor RAL

ACESSÓRIOS

-  Domotic Touch
-  Mimoo Switch
-  Mimoo Switch Round

VERSÃO

-  Elétrico

MATERIAL

-  Aço Inoxidável
-  Aço Carbono

VERSÃO: ELÉTRICO II

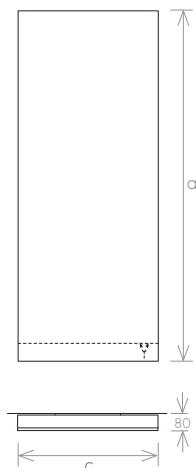

VERSÃO: ELÉTRICO II

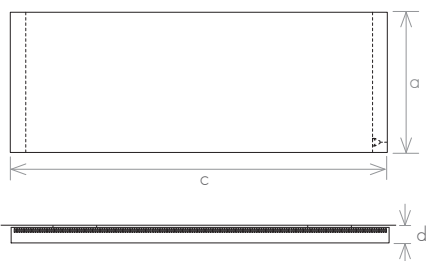

interruptor on/off com LED
voltagem AC 230-240V

modelo		PP6501200	PP6501800	PP6502000	PP10001000	PP1800550	PP2000550	PP1800650	PP2000650
altura (mm)	a	650	650	650	1000	1800	2000	1800	2000
largura total (mm)	c	1200	1800	2000	1000	550	550	650	650
profundidade (mm)	d	80	80	80	80	80	80	80	80
elétrico II (W)		1200	1600	2000	1200	1600	2000	1600	2000

PLANO +

RADIADOR



ACABAMENTOS

-  Polido
-  Escovado
-  Forja
-  Branco 9016 Satinado
-  Cor RAL

VERSÃO

-  Aquecimento Central

MATERIAL

-  Aço Inoxidável
-  Aço Carbono

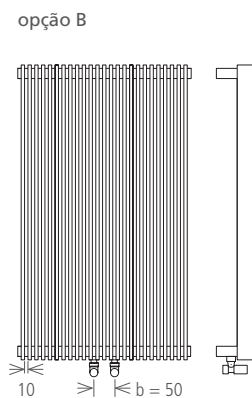
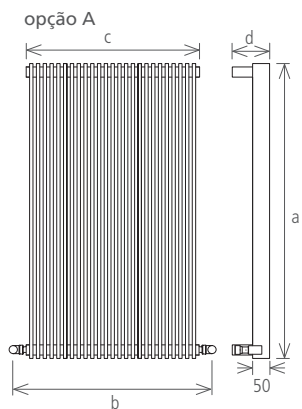

opção C

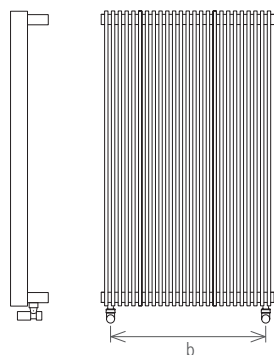

opção D

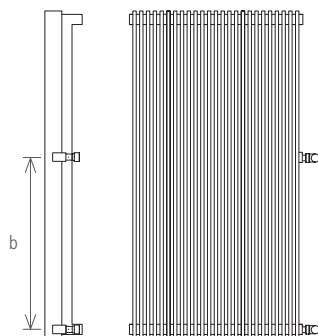

* Diferentes posições entre eixos das torneiras à escolha do cliente.

modelo	P+1200 10	P+1400 10	P+1800 10	P+2000 10	P+1200 25	P+1400 25	P+1800 25
nº de elementos	10	10	10	10	25	25	25
altura (mm) a	1200	1400	1800	2000	1200	1400	1800
largura total (mm) c	210	210	210	210	510	510	510
profundidade (mm) d	120	120	120	120	120	120	120
capacidade (l)	4,25	4,91	6,23	6,89	10,61	12,26	15,55
peso (kg)	17,14	19,90	25,42	28,18	42,81	49,71	63,51
aquec. central (W)	782	901	1136	1256	1960	2259	2845

modelo	P+2000 25	P+1200 31	P+1400 31	P+1800 31	P+2000 31	P+1200 36	P+1400 36
nº de elementos	25	31	31	31	31	36	36
altura (mm) a	2000	1200	1400	1800	2000	1200	1400
largura total (mm) c	510	630	630	630	630	730	730
profundidade (mm) d	120	120	120	120	120	120	120
capacidade (l)	17,19	13,16	15,20	19,28	21,32	15,28	17,65
peso (kg)	70,41	53,08	61,64	78,75	87,31	61,64	71,57
aquec. central (W)	3146	2432	2801	3157	3902	2826	3257

modelo	P+2000 60	P+251200	P+25 1400	P+25 1800	P+31 1200	P+31 1400	P+31 1800
nº de elementos	60	25	25	25	31	31	31
altura (mm) a	2000	510	510	510	630	630	630
largura total (mm) c	1210	1200	1400	1800	1200	1400	1800
profundidade (mm) d	120	120	120	120	120	120	120
capacidade (l)	41,24	10,61	12,26	15,55	13,16	15,20	19,28
peso (kg)	168,95	42,81	49,71	63,51	53,08	61,64	78,75
aquec. central (W)	7520	1960	2259	2845	2432	2801	3157

opção E

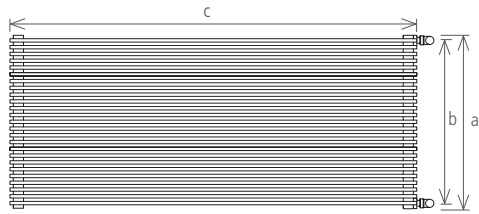

opção F

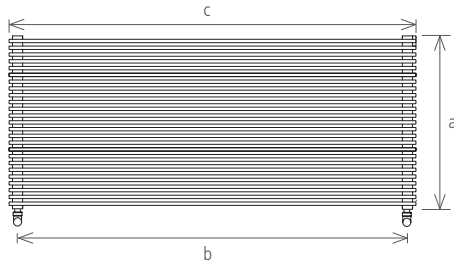

opção G

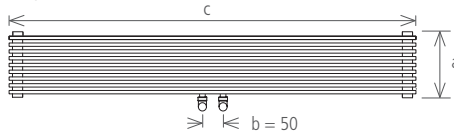

P+1800 36 P+2000 36 P+1200 40 P+1400 40 P+1800 40 P+2000 40 P+1200 60 P+1400 60 P+1800 60

36	36	40	40	40	40	60	60	60
1800	2000	1200	1400	1800	2000	1200	1400	1800
730	730	810	810	810	810	1210	1210	1210
120	120	120	120	120	120	120	120	120
22,38	24,75	16,97	19,60	24,87	27,50	25,45	29,40	37,30
91,45	101,38	68,48	79,52	101,60	112,71	102,71	119,27	152,39
4099	4530	3139	3619	4557	5030	4706	5427	6820

P+36 1200 P+36 1400 P+36 1800 P+40 1200 P+40 1400 P+40 1800 P+60 1200 P+60 1400 P+60 1800

36	36	36	40	40	40	60	60	60
730	730	730	810	810	810	1210	1210	1210
1200	1400	1800	1200	1400	1800	1200	1400	1800
120	120	120	120	120	120	120	120	120
15,28	17,65	22,38	16,97	19,60	24,87	25,45	29,40	37,30
61,64	71,57	91,45	68,48	79,52	101,60	102,71	119,27	152,39
2826	3257	4099	3139	3619	4557	4706	5427	6820

PLANO

RADIADOR

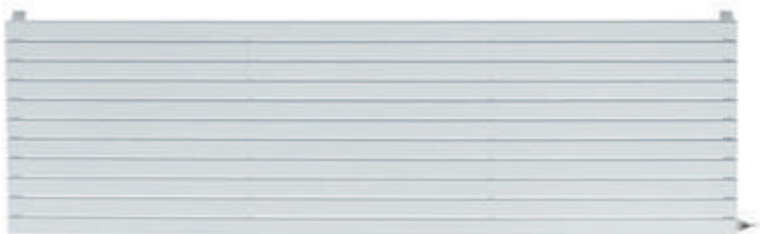

VERSÃO: ELÉTRICO II

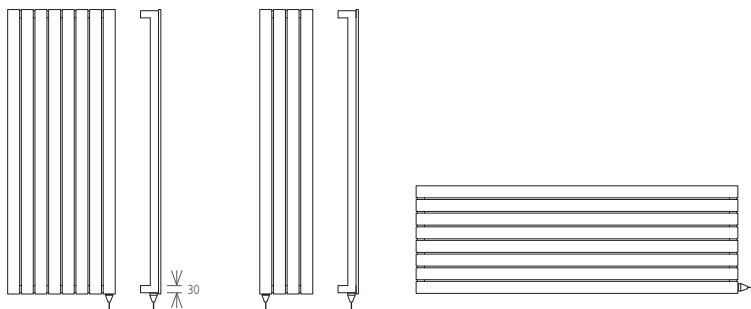

modelo		P1200 4	P1400 4	P1800 4	P2000 4	P1200 8	P1400 8	P1800 8	P2000 8	P1200 9
n° de elementos		4	4	4	4	8	8	8	8	9
altura (mm)	a	1200	1400	1800	2000	1200	1400	1800	2000	1200
largura total (mm)	c	221	221	221	221	449	449	449	449	506
profundidade (mm)	d	85	85	85	85	85	85	85	85	85
capacidade (l)		2,01	2,29	2,98	3,25	4,10	4,70	5,98	6,32	4,54
peso (kg)		7,24	8,34	10,55	11,65	14,49	16,70	21,12	23,32	16,31
aquec. central (W)		325	379	469	497	654	733	925	956	713
elétrico (W)		600	600	600	600	1000	1000	1000	1000	1200

modelo		P1400 14	P1800 14	P2000 14	P1200 21	P1400 21	P1800 21	P2000 21	P9 1200	P9 1400
n° de elementos		14	14	14	21	21	21	21	9	9
altura (mm)	a	1400	1800	2000	1200	1400	1800	2000	506	506
largura total (mm)	c	791	791	791	1190	1190	1190	1190	1200	1400
profundidade (mm)	d	85	85	85	85	85	85	85	85	85
capacidade (l)		7,60	9,44	10,37	10,03	11,41	14,17	15,55	4,54	5,30
peso (kg)		29,24	36,97	40,83	38,07	43,87	55,46	62,55	16,31	18,79
aquec. central (W)		1276	1594	1603	1649	1899	2390	2641	713	829
elétrico (W)		2000	2000	2000	2000	2000	2000	2000	1200	1200

opção A

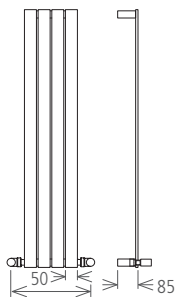

opção B

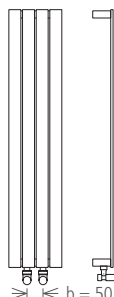

opção C

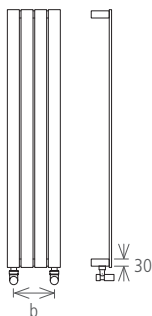

opção D

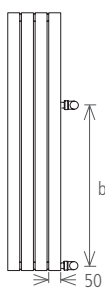

opção E

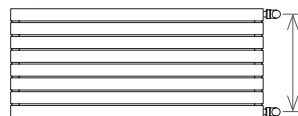

opção G

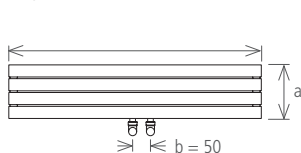

opção F

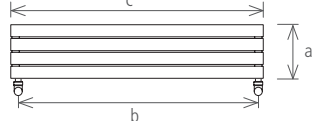

* Diferentes posições entre eixos das torneiras à escolha do cliente.



P1400 9	P1800 9	P2000 9	P1200 10	P1400 10	P1800 10	P2000 10	P1200 11	P1400 11	P1800 11	P2000 11	P1200 14
9	9	9	10	10	10	10	11	11	11	11	14
1400	1800	2000	1200	1400	1800	2000	1200	1400	1800	2000	1200
506	506	506	563	563	563	563	620	620	620	620	791
85	85	85	85	85	85	85	85	85	85	85	85
5,30	6,69	7,21	5,11	5,97	7,44	8,10	5,71	6,51	8,26	8,74	6,68
18,79	23,76	26,24	18,12	20,88	26,40	29,16	19,93	22,97	29,04	32,08	25,38
829	1022	1117	814	933	1142	1263	864	997	1262	1388	1106
1600	2000	2000	1200	1200	2000	2000	1600	2000	2000	2000	2000

P9 1800	P10 1200	P10 1400	P10 1800	P11 1200	P11 1400	P11 1800	P14 1200	P14 1400	P14 1800	P21 1200	P21 1400
9	10	10	10	11	11	11	14	14	14	21	21
506	563	563	563	620	620	620	791	791	791	1190	1190
1800	1200	1400	1800	1200	1400	1800	1200	1400	1800	1200	1400
85	85	85	85	85	85	85	85	85	85	85	85
6,69	5,11	5,97	7,44	5,71	6,51	8,26	6,68	7,60	9,44	10,03	11,41
23,76	18,12	20,88	26,40	19,93	22,97	29,04	25,38	29,24	36,97	38,07	43,87
1002	814	933	1142	864	997	1262	1106	1276	1594	1649	1899
1200	1200	1200	1200	1200	1600	2000	1600	1600	2000	1600	2000

DOMOTIC TOUCH

TECNOLOGIA

Domotic Touch é uma solução simples com parâmetros de instalação de um simples interruptor.

Funcionalidade económica

Aumenta a eficiência energética através da programação do número de horas de funcionamento (uma, duas ou três horas).

Funcionalidade conforto

Permite a racionalização dos gastos de energia pela funcionalidade de controlo de temperatura (18°C, 20°C, 22°C, 24°C).

Com o seu sensor de temperatura de leitura ambiente esta funcionalidade permite seleccionar a temperatura desejada para o seu conforto no espaço de banho.

Flexibilidade

A domótica permite a gestão de um ou mais radiadores ou toalheiros eléctricos para o mesmo espaço de banho.

Modo Duty-Cycle

Função a ser usada para um controlo mais personalizado da temperatura do equipamento. A activação deste modo é dada pelo indicador luminoso acima do icon.

Funcionamento temporizado a 25%, 50%, 75% e 100% com período base de 20 minutos.

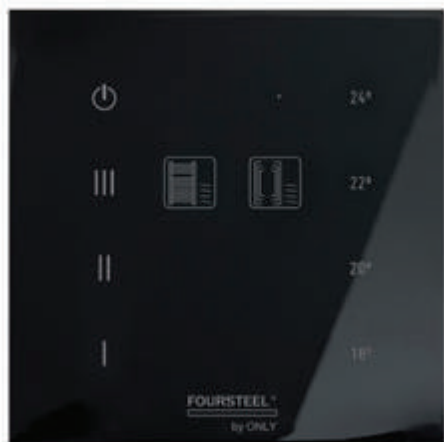

VIDRO PRETO



VIDRO SATINADO

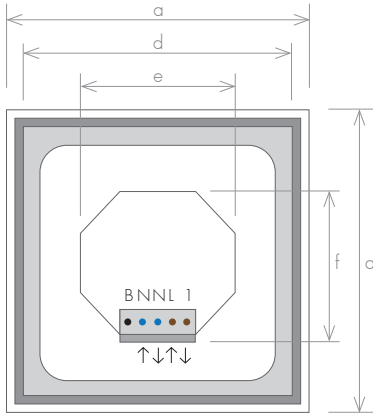

	modelo	DT
medida total exterior (mm)	a	90 x 90
espessura exterior (mm)	b	5
profundidade da caixa interior (mm)	c	40
medida total interior (mm)	d	73 x 73
medida horizontal posterior (mm)	e	55
medida vertical posterior (mm)	f	51
	-	B
entrada neutro		N
saída neutro radiador toalheiro		N
entrada fase		L
saída fase radiador toalheiro		1

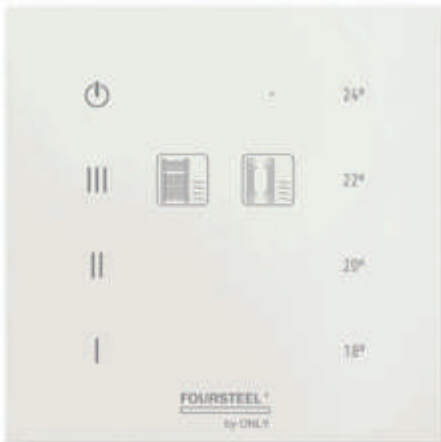

BRANCO MATE



PRETO MATE



SWITCH ON OFF

Ø60MM X 70MM | IP54

CLASS 2

110V - 230V



PVD OIRO ESCOVADO

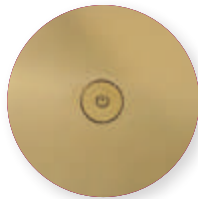

PVD OIRO POLIDO



ESCOVADO



POLIDO



PVD COBRE ESCOVADO

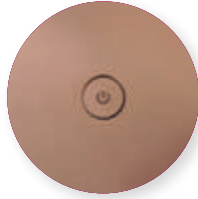

PVD COBRE POLIDO



FORJA



BRANCO 9016 SATINADO

SWITCH ON OFF



Ø60MM X 70MM | IP54

CLASS 2

110V - 230V

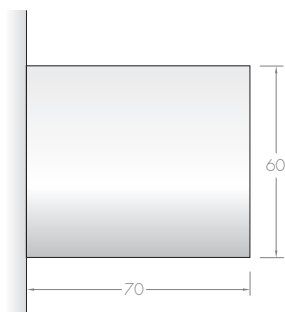
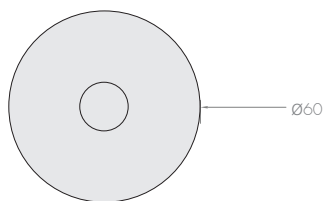



MIMOO SWITCH

80MM X 80MM X 6MM | IP54

CLASS 2

110V - 230V



PVD OURO ESCOVADO



PVD OURO POLIDO



ESCOVADO

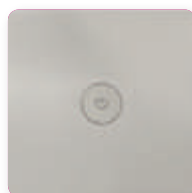

POLIDO



PVD COBRE ESCOVADO



PVD COBRE POLIDO



FORJA

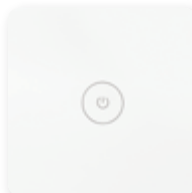

BRANCO 9016 SATINADO



MIMOO SWITCH ROUND

85MM X 6MM | IP54

CLASS 2

110V - 230V



PVD OURO ESCOVADO

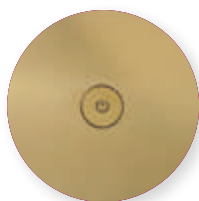

PVD OURO POLIDO



ESCOVADO



POLIDO

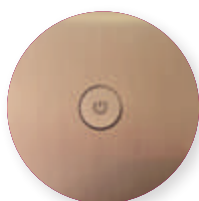

PVD COBRE ESCOVADO

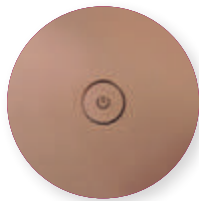

PVD COBRE POLIDO



FORJA



BRANCO 9016 SATINADO

MIMOO SWITCH

MIMOO SWITCH



80MM X 80MM X 6MM | IP54
CLASS 2
110V - 230V

VISTA LATERAL

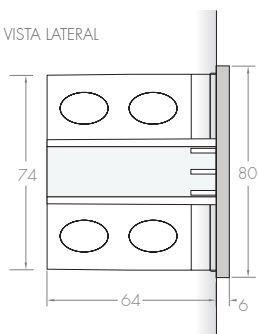

VISTA FRONTAL

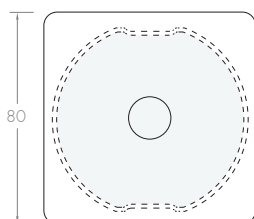

MIMOO SWITCH ROUND



Ø85MM X 6MM | IP54
CLASS 2
110V - 230V

VISTA LATERAL

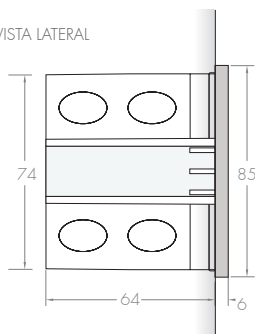

VISTA FRONTAL

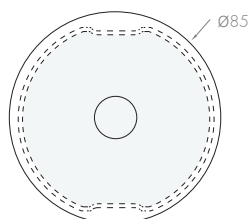

ELEMENTOS ELÉTRICOS

ELEMENTO ELÉTRICO I
só disponível para Portugal



CLASSE 1 | IP X4
ORIENTAÇÃO VERTICAL
ON / OFF
REGULADOR DE TEMPERATURA

ELEMENTO ELÉTRICO II



CLASSE 2 | IP 64
ORIENTAÇÃO VERTICAL
ORIENTAÇÃO HORIZONTAL

ELEMENTO ELÉTRICO III
só disponível para Portugal



CLASSE 1 | IP 65
ORIENTAÇÃO VERTICAL
ON / OFF
REGULADOR DE TEMPERATURA

ELEMENTO ELÉTRICO IV



CLASSE 2 | IP 65
ORIENTAÇÃO VERTICAL
ORIENTAÇÃO HORIZONTAL
ON / OFF
REGULADOR DE TEMPERATURA
TEMPORIZADOR 2H
LEITURA AMBIENTE

ELEMENTO ELÉTRICO V



CLASSE 2 | IP X4
ORIENTAÇÃO VERTICAL
ON / OFF
REGULADOR DE TEMPERATURA
TEMPORIZADOR 2H
LEITURA AMBIENTE

ELEMENTO ELÉTRICO VI



CLASSE 2 | IP X4
ORIENTAÇÃO VERTICAL
ON / OFF
REGULADOR DE TEMPERATURA
TEMPORIZADOR 2H
LEITURA AMBIENTE
PROGRAMÁVEL

VÁLVULAS E RETENTORES

KIT TORNEIRAS 1

Válvula e retentor manual esquadria quadrada

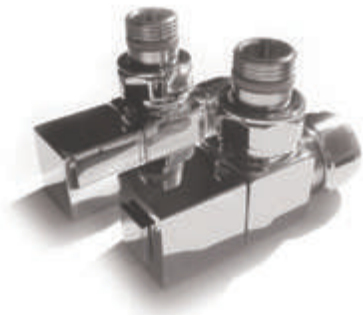

KIT TORNEIRAS 2

Válvula e retentor manual esquadria quadrada



KIT TORNEIRAS 3

Válvula e retentor manual esquadria redonda



KIT TORNEIRAS 4

Válvula e retentor manual esquadria redonda



KIT TORNEIRAS 5

Válvula manual Rewind

estilo francês

estilo inglês



KIT TORNEIRAS 6

Válvula e retentor manual diretos

Válvula e retentor manual diretos

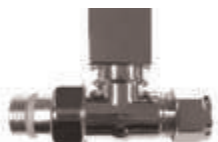

KIT TORNEIRAS 7

Válvula e retentor manual esquadria redonda



KIT TERMOSTÁTICO 1

Cabeça termostática + Capoteamento

Válvula termostática

Retentor



KIT TERMOSTÁTICO 2

Válvula com cabeça termostática

Retentor



KIT TERMOSTÁTICO 3

Válvula termostática



Válvula termostática



Retenor



KIT MURAL 1

Torneiras termostáticas



SUPORTES

Suporte I



Suporte II



PURGADORES

Purgador 1/2"

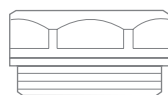

Purgador 1/8"

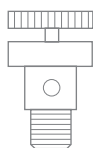

ADAPTADOR MISTO I

Adaptador meia esquadria para versão mista



ADAPTADOR MISTO II

Adaptador meia esquadria para versão mista



NOTAS IMPORTANTES:

1. Quando não identificado a posição do elemento elétrico será sempre colocado do lado inferior direito;
2. Todos os nossos radiadores elétricos são compostos por elemento elétrico e fluido térmico.
3. A Foursteel® reserva o direito de alteração, sem aviso prévio, de todos os produtos e desenhos que constem neste catálogo.
4. Todos os produtos Foursteel® são adaptáveis em termos de potências e dimensões.

CORES RAL: cores sujeitas a confirmação.

BRANCO: RAL 9016 satinado (RAL usado por definição)

Certificação dos produtos elétricos, segundo a norma:

IECEN 60335-2-43:

IEC 60335-1:2010 + COR1: 2010 + COR2:2011 + A1:2013 EN 60335-1:2012 + AC:2014 + A11:2014

IEC 60335-2-43:2002 + A1:2005 + A2:2008 EN 60335-2-43:2003 + A1:2006 + A2:2008

Certificação dos produtos de aquecimento central, segundo a norma UN:

EN442 - 2

Certificação UL:

UL 499 - Electric Heating Appliances

E506585

